

# EIC-1000 USER

Arm-based Edge AI Computing System

Dual Cortex-A72, Quad Cortex-A53 Processor, 9V to 55V, 0°C to 70°C Operation

# Manual

# Record of Revision

---

Version	Date	Page	Description	Remark
1.00	2021/12/7	All	Official Release	

## Disclaimer

This manual is released by Vecow Co., Ltd. for reference purpose only. All product offerings and specifications are subject to change without prior notice. It does not represent commitment of Vecow Co., Ltd. Vecow shall not be liable for direct, indirect, special, incidental, or consequential damages arising out of the use of the product or documentation or any infringements upon the rights of third parties, which may result from such use.

## Declaration of Conformity

**FCC** This equipment has been tested and found to comply with the limits for a Class A digital device, pursuant to part 15 of the FCC Rules. These limits are designed to provide reasonable protection against harmful interference when the equipment is operated in a commercial environment. This equipment generates, uses, and can radiate radio frequency energy, and if it is not installed and used in accordance with the instruction manual, it may cause harmful interference to radio communications. Operation of this equipment in a residential area is likely to cause harmful interference in which case the user will be required to correct the interference at his own expense.

**CE** The products described in this manual complies with all applicable European Union (CE) directives if it has a CE marking. For computer systems to remain CE compliant, only CE-compliant parts may be used. Maintaining CE compliance also requires proper cable and cabling techniques.

## Copyright and Trademarks

This document contains proprietary information protected by copyright. No part of this publication may be reproduced in any form or by any means, electric, photocopying, recording or otherwise, without prior written authorization by Vecow Co., Ltd. The rights of all the brand names, product names, and trademarks belong to their respective owners.

## Order Information

---

Part Number	Description
EIC-1000-DB	EIC-1000, Rockchip RK3399, Pre-installed with Debian 9.0, 1 GigE LAN, 1 USB 3.0, 1 USB 2.0, 1 Digital Display, 2 COM, 0°C to 70°C
EIC-1000-AD	EIC-1000, Rockchip RK3399, Pre-installed with Android 7.1, 1 GigE LAN, 1 USB 3.0, 1 USB 2.0, 1 Digital Display, 2 COM, 0°C to 70°C

## Optional Accessories

---

Part Number	Description
PWA-60WP3-WT	60W, 24V, 90V AC to 264V AC Power Adapter with 3-pin Terminal Block, Wide Temperature -30°C to +70°C
PWA-60WP3-WT-12V	60W, 12V, 90V AC to 264V AC Power Adapter with 3-pin Terminal Block, Wide Temperature -30°C to +70°C
DIN-RAIL	DIN Rail Kit for EIC-1000
WiFi & Bluetooth	WiFi & Bluetooth Module with Antenna

# Table of Contents

<b>CHAPTER 1</b>	<b>GENERAL INTRODUCTION</b>	<b>1</b>
	1.1 Overview	1
	1.2 Features	2
	1.3 Product Specification	3
	1.3.1 Specifications of EIC-1000-DB	3
	1.3.2 Specifications of EIC-1000-AD	5
	1.4 Mechanical Dimensions of EIC-1000	7
<b>CHAPTER 2</b>	<b>GETTING TO KNOW YOUR EIC-1000</b>	<b>8</b>
	2.1 Packing List	8
	2.2 Front Panel I/O & Functions	9
	2.3 Rear Panel I/O Functions	14
	2.4 Main Board Connectors & Jumper Locations	15
<b>CHAPTER 3</b>	<b>SYSTEM SETUP</b>	<b>25</b>
	3.1 How to Open Your EIC-1000	25
	3.2 Installing SD Card	26
	3.3 Installing Mini PCIe	27
	3.4 Installing Antenna Cable	28
	3.5 Mount Your EIC-1000	29
<b>CHAPTER 4</b>	<b>SOFTWARE SETUP</b>	<b>31</b>
	4.1 Prerequisites	31
	4.2 USB Debug Bridge	33
	4.3 GPIO	39
	4.4 Serial Port	40
	4.5 Ethernet	41

<b>4.6 Camera</b>	<b>42</b>
<b>4.7 Storage</b>	<b>43</b>
<b>4.8 Display</b>	<b>49</b>
<b>4.9 Audio</b>	<b>51</b>

## **APPENDIX A : POWER CONSUMPTION** **53**

# 1

## GENERAL INTRODUCTION

### 1.1 Overview

EIC-1000 is an Arm-based Edge AI Computing System. Based on Rockchip RK3399 SoC, EIC-1000 delivers high-performance, scalability and outstanding visualized functionality for industry deployments to implement AIoT applications faster.

Vecow EIC-1000 is powered by dual-core Cortex-A72 and quad-core Cortex-A53 processor and runs on Arm Mali-T860MP4 GPU. To meet the market demand for increased storage capabilities within digital signage and smart retail, EIC-1000 offers 2GB DDR3 SDRAM, 32GB eMMC and 1 external Micro SD and supports digital display at up to 4K resolution. Furthermore, the EIC-1000 supports Android and Linux operating system, which allows users to work seamlessly across industries.

With 9V to 55V wide DC-in and operating temperature range of 0°C to 70°C, the EIC-1000 provides trusted reliability to a wide range of applications including Digital Signage, Factory Automation, Smart Retail, and any AIoT/Industry 4.0 applications.



## 1.2 Features

- Rockchip Dual Cortex-A72, Quad Cortex-A53 Processor
- 2GB DDR3 SDRAM, 32GB eMMC, 1 External Micro SD Socket
- Pre-installed with Debian 9.0 or Android 7.1
- 1 Digital Display, up to 4K resolution
- 1 GigE LAN, 1 USB 3.1, 1 USB 2.0
- 2 COM RS-232/422/485, Audio Mic-in and Line-out
- 1 Half-size Mini PCIe for WiFi/Bluetooth
- DC 9V to 55V wide range power input
- Fanless, 0°C to 70°C Operating Temperature

## 1.3 Product Specification

### 1.3.1 Specifications of EIC-1000-DB

<b>System</b>	
Processor	Rockchip RK3399 Arm Dual-core Cortex-A72 + Quad-core Cortex-A53
Memory	1 DDR3L 1066MHz SDRAM, 2GB
eMMC	1 eMMC, 32GB
OS	<ul style="list-style-type: none"><li>• Linux Debian 9.0</li><li>• Supports bootup from eMMC</li></ul>
<b>Graphics</b>	
Interface	1 Digital Display, up to 4Kx2K @60fps
Graphics Processor	ARM Mail-T860MP4, AFBC supported
Video Decoder	<ul style="list-style-type: none"><li>• H.264/H.265, 10bit, up to 4Kx2K@60fps</li><li>• VP9, 8bit, up to 4Kx2K@60fps</li><li>• MPEG-4/MPEG-2/VP8 up to 1080p@60fps</li></ul>
Video Encoder	H.264/MVC/VP8 encoders by 1080p@30fps
<b>I/O Interface</b>	
USB	<ul style="list-style-type: none"><li>• 1 USB 3.1 Type A</li><li>• 1 USB 2.0 Type A</li></ul>
Serial	2 COM RS-232/422/485
Button	<ul style="list-style-type: none"><li>• 1 Power Button</li><li>• 1 Reset Button</li></ul>
Antenna	2 Antenna for WiFi/Bluetooth
<b>Expansion</b>	
Mini PCIe	1 Half-size Mini PCIe Slot (USB 2.0)
USB	2 USB 2.0 Port Wafer
<b>Storage</b>	
Storage Device	1 Micro SD Card (External)
<b>Ethernet</b>	
LAN	10/100/1000 Base-T Ethernet GigE LAN, RJ45 Connector
<b>Audio</b>	
Audio Codec	Realtek ALC5640 low power stereo codec
Audio Interface	1 Mic-in, 1 Line-out
<b>Power</b>	
Power Input	9V to 55V, DC-in
Power Interface	3-pin Terminal Block : V+, V-, Frame Ground

<b>Mechanical</b>	
Dimensions	136.0mm x 110.0mm x 46.8mm (5.35" x 4.33" x 1.84")
Weight	0.4kg (0.9 lb)
Mounting	<ul style="list-style-type: none"> <li>• Wallmount by mounting bracket</li> <li>• DIN Rail Mount (Optional)</li> </ul>
<b>Environment</b>	
Operating Temperature	0°C to 70°C (32°F to 131°F)
Storage Temperature	-40°C to 85°C (-40°F to 185°F)
Humidity	5% to 95% Humidity, non-condensing
Relative Humidity	95% at 70°C
Shock	IEC 60068-2-27
Vibration	IEC 60068-2-64
EMC	CE, FCC, EN50155, EN50121-3-2

### 1.3.2 Specifications of EIC-1000-AD

<b>System</b>	
Processor	Rockchip RK3399 Arm Dual-core Cortex-A72 + Quad-core Cortex-A53
Memory	1 DDR3L 1066MHz SDRAM, 2GB
eMMC	1 eMMC, 32GB
OS	<ul style="list-style-type: none"> <li>• Android 7.1</li> <li>• Supports bootup from eMMC</li> </ul>
<b>Graphics</b>	
Interface	1 Digital Display, up to 4Kx2K @60fps
Graphics Processor	ARM Mail-T860MP4, AFBC supported
Video Decoder	<ul style="list-style-type: none"> <li>• H.264/H.265, 10bit, up to 4Kx2K@60fps</li> <li>• VP9, 8bit, up to 4Kx2K@60fps</li> <li>• MPEG-4/MPEG-2/VP8 up to 1080p@60fps</li> </ul>
Video Encoder	H.264/MVC/VP8 encoders by 1080p@30fps
<b>I/O Interface</b>	
USB	<ul style="list-style-type: none"> <li>• 1 USB 3.1 Type A</li> <li>• 1 USB 2.0 Type A</li> </ul>
Serial	2 COM RS-232/422/485
Button	<ul style="list-style-type: none"> <li>• 1 Power Button</li> <li>• 1 Reset Button</li> </ul>
Antenna	2 Antenna for WiFi/Bluetooth
<b>Expansion</b>	
Mini PCIe	1 Half-size Mini PCIe Slot (USB 2.0)
USB	2 USB 2.0 Port Wafer
<b>Storage</b>	
Storage Device	1 Micro SD Card (External)
<b>Ethernet</b>	
LAN	10/100/1000 Base-T Ethernet GigE LAN, RJ45 Connector
<b>Audio</b>	
Audio Codec	Realtek ALC5640 low power stereo codec
Audio Interface	1 Mic-in, 1 Line-out
<b>Power</b>	
Power Input	9V to 55V, DC-in
Power Interface	3-pin Terminal Block : V+, V-, Frame Ground
<b>Mechanical</b>	
Dimensions	136.0mm x 110.0mm x 46.8mm (5.35" x 4.33" x 1.84")
Weight	0.4kg (0.9 lb)
Mounting	<ul style="list-style-type: none"> <li>• Wallmount by mounting bracket</li> <li>• DIN Rail Mount (Optional)</li> </ul>

<b>Environment</b>	
Operating Temperature	0°C to 70°C (32°F to 131°F)
Storage Temperature	-40°C to 85°C (-40°F to 185°F)
Humidity	5% to 95% Humidity, non-condensing
Relative Humidity	95% at 70°C
Shock	IEC 60068-2-27
Vibration	IEC 60068-2-64
EMC	CE, FCC, EN50155, EN50121-3-2

# 1.4 Mechanical Dimensions of EIC-1000

Unit : mm (inch)

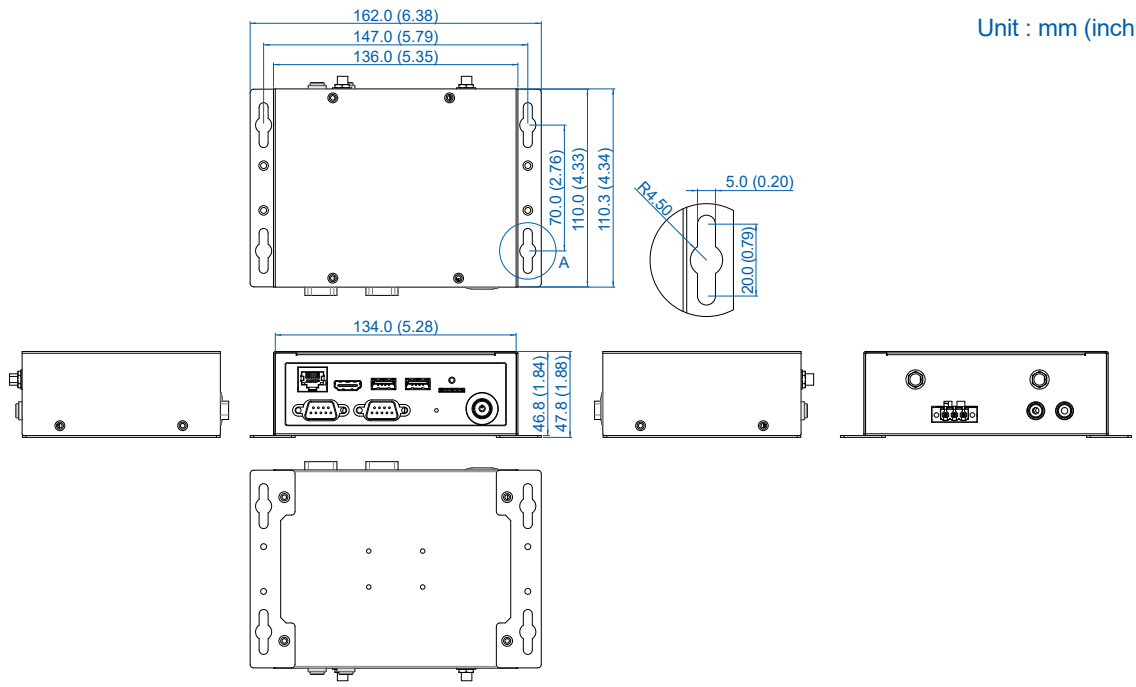





# 2

## GETTING TO KNOW YOUR EIC-1000

### 2.1 Packing List

Item	Description	Qty
1	EIC-1000 Arm-based Edge AI Computing System (According to the configuration of you order, EIC-1000 series may contain Micro SD and M.2 module. Please verify these items if necessary.)	1

Item	Description	Outlook	Usage	P/N	Qty
1	Terminal block 3-pin (5.0mm)		DC-IN	51-2411R03-S1K	1
2	SD Cover		Micro SD Protection	62-00P0911-0AA	1
3	Wall Mount Bracket		Wall Mount Bracket	62-03P0834-000	2
4	Flat M3x4L		Fasten wall mount bracket to EIC-1000 series	53-M000450-301	4
5	PHILLPIS M2 x 4L, Ni		Mini PCIe	53-M013010-000	2

## 2.2 Front Panel I/O & Functions

In Vecow EIC-1000 series, all of the I/O connectors are located on the front and rear panels. Most of the general connections to computer devices, such as USB, LAN, Digital Display and COM port are placed on the front panel.

### 2.2.1 Power Button and LED

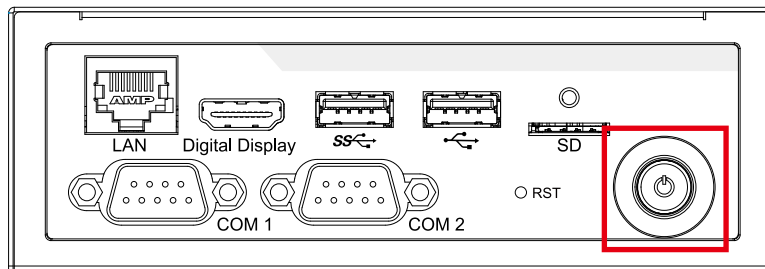

The Power Button is a latched switch with LED indication.

To power on the system, press the power button and then the blue power LED is lightened.

To power off the system, push to release the power button. For Debian OS, you can also command shutdown by OS operation.

To boot on the system, please press the Power button. To shut down the system, please press the button again. The blue power LED indicates the system's power is plugged.

### 2.2.2 Reset Button

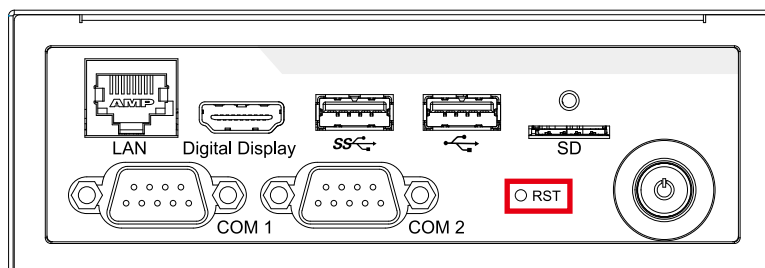

The Reset Button is used to reset the system without powering off the system. Press the Reset Button for a few seconds, then reset will be enabled.



## 2.2.3 Micro SD

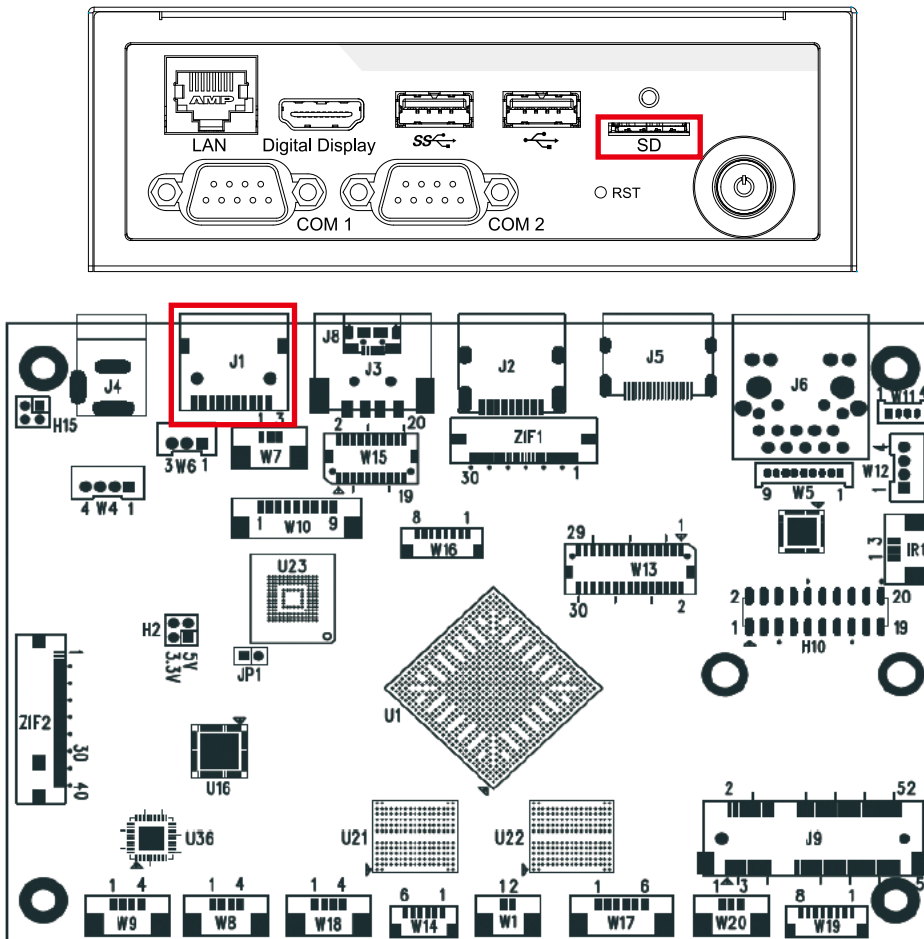

The external Micro SD card provides additional storage expansion. The Micro SD card slot supports SD card capacity up to 256GB. If you would like to replace or insert the card, **it MUST be ensured that the system is powered off.**

## 2.2.4 USB 2.0

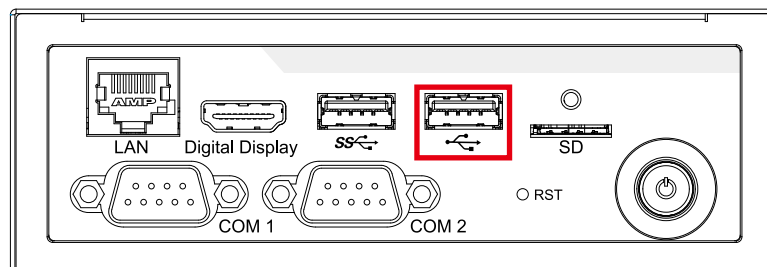

The USB interface supports 480Mbps transfer rate complied with high speed USB specification Rev. 2.0.

## 2.2.5 USB 3.0

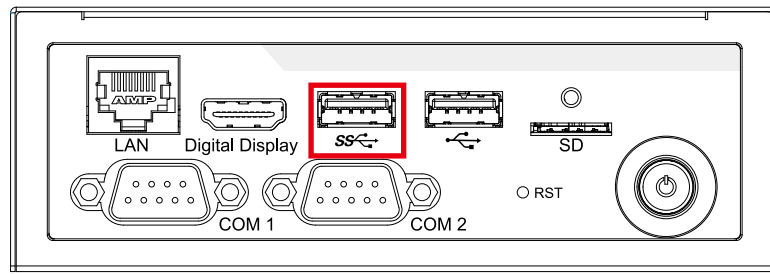

The USB 3.0 port supports up to 5GB per second data rate in the front side of EIC-1000.

Under Linux OS environment, the USB 3.0 port is in host mode.

Under Android OS environment, the USB 3.0 port can be set to host or device mode. Please refer to Section 4.2 for details.

## 2.2.6 Digital Display Port

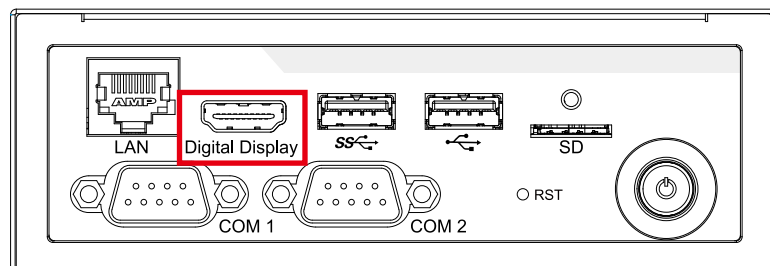

Onboard Digital Display Port supports DDC channel mode. The connection supports up to 3840 x 2160 resolution at 60Hz.

## 2.2.7 Ethernet Port

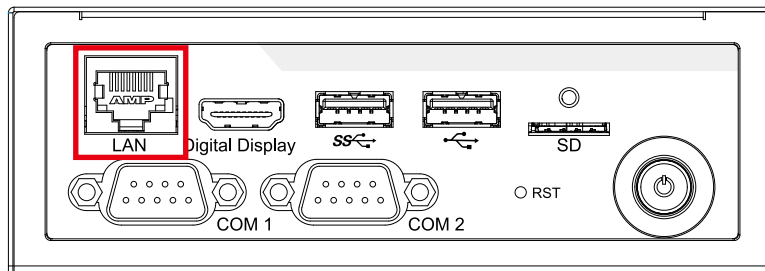

There is one 8-pin RJ-45 jack supporting 10/100/1000 Mbps Ethernet connections in the front side. Plugged in suitable RJ-45 cable, this port can create Ethernet connection from the system to any other devices, such as a computer, a hub or a switch. The pin-outs of LAN 1 and LAN 2 are listed as follows :

Pin No.	10/100 Mbps	1000Mbps
1	E_TX+	MDI0_P
2	E_TX-	MDI0_N
3	E_RX+	MDI1_P
4	----	MDI2_P
5	----	MDI2_N
6	E_RX-	MDI1_N
7	----	MDI3_P
8	----	MDI3_N

The LAN port is supported by standard RJ-45 connector with LED indicators to present Active/Link/Speed status of the connection.

The LED indicator on the left bottom corner lightens in solid red when the cable is properly connected to a 10/100 Mbps Ethernet network; The LED indicator on the left bottom corner lightens in solid green when the cable is properly connected to a 1000Mbps Ethernet network; The right LED will keep twinkling/off when Ethernet data packets are being transmitted/received.

LED Location	LED Color	10/100 Mbps	1000Mbps
Left	Red/Green	Solid Red	Solid Green
Right	Green	Twinkling Green	Twinkling Green

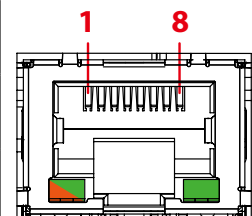

## 2.2.8 Serial Port (J12, J13)

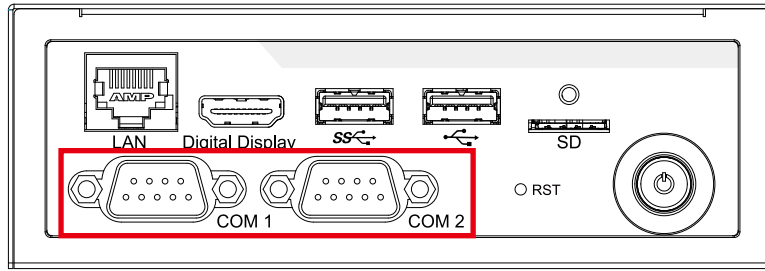

COM1 and COM2 can be configured for RS-232, RS-422, or RS-485. The default definition of COM 1 and COM 2 is RS-232. To change to RS-422 or RS-485, please refer to Section 4.4.

For RS-232, the data rate is 1.5Mbps with maximum load of 150pF. For RS-422/RS-485, the data rate is 10Mbps with maximum load of 47pF.

The operation modes can be selected by software configuration :

Mode	Description	Status
0	RS-422 Full Duplex	1T/1R RS-422
1	Pure RS-232	3T/5R RS-232.
2	RS-485 Half Duplex	1T/1R RS-485, TX ENABLE Low Active
3	RS-485 Half Duplex	1T/1R RS-485, TX ENABLE High Active
4	RS-422 Full Duplex	1T/1R RS-422 with termination resistor (120 ohm) and bias Resistor (1K ohm)
5	Reserved	Reserved
6	RS-485 Half Duplex	1T/1R RS-485 with termination resistor and bias resistor. TX ENABLE Low Active
7	Low Power Shutdown	All I/O pins are High Impedance

The pin assignments are listed in the following table :

Serial Port	Pin No.	RS-232	RS-422	RS-485
1 to 2	1	DCD	TXD-	DATA-
	2	RXD	TXD+	DATA+
	3	TXD	RXD+	----
	4	DTR	RXD-	----
	5	GND	GND	GND
	6	DSR	----	----
	7	RTS	----	----
	8	CTS	----	----
	9	RI	----	----

## 2.3 Rear Panel I/O Functions

### 2.3.1 Power Terminal Block

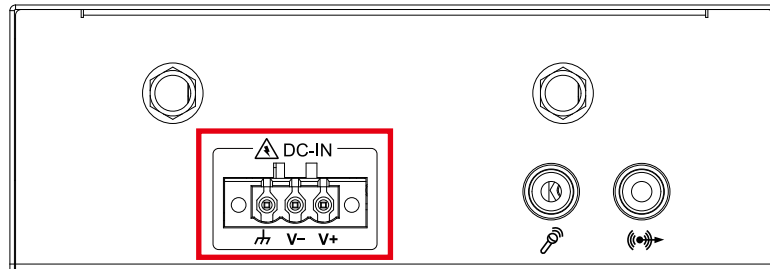

EIC-1000 supports 9V to 55V DC wide range power input by terminal block.

Pin No.	Definition	Pin No.	Definition
1	V+	2	V-
3	Chassis Ground		

### 2.3.2 Audio Codec Interface (H10)

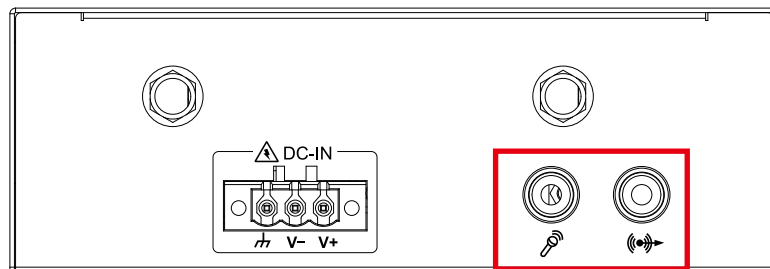

There are 2 audio connectors, Mic-in and Line-out, in the rear side of EIC-1000. Onboard Realtek ALC5640 low power stereo codec supports speaker amplifiers 1.5W per channel into 8Ω or 2W per channel into 4Ω.

## 2.4 Main Board Connectors & Jumper Locations

### 2.4.1 Top View (Component Side) of EIC-1000 Main Board with Connector Location

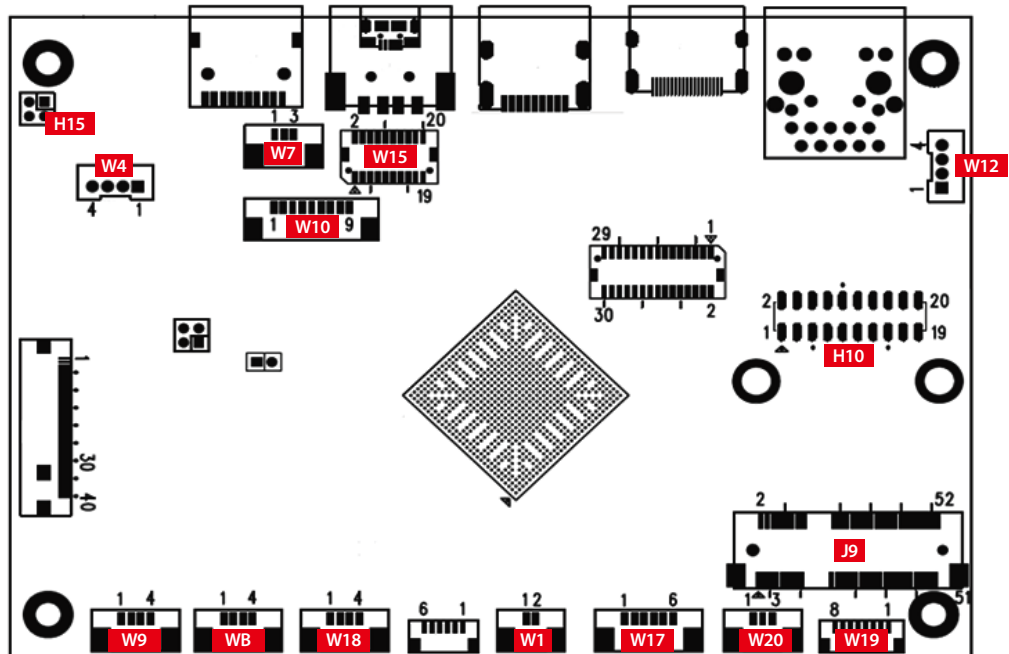

### 2.4.2 Bottom View (Solder Side) of EIC-1000 Main Board with Connector Location

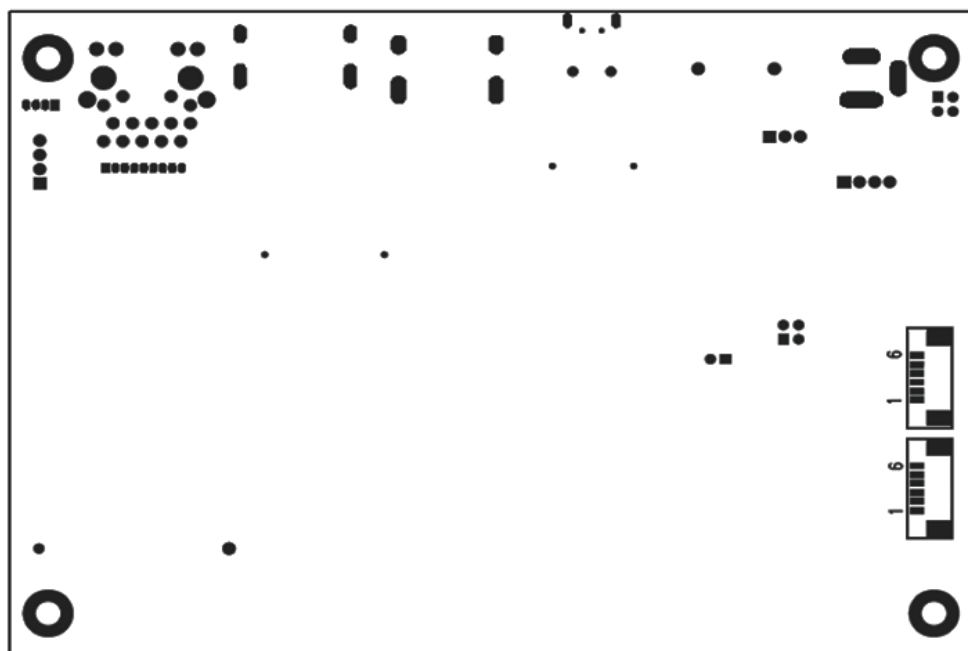

### 2.4.3 H15 : Power Switch

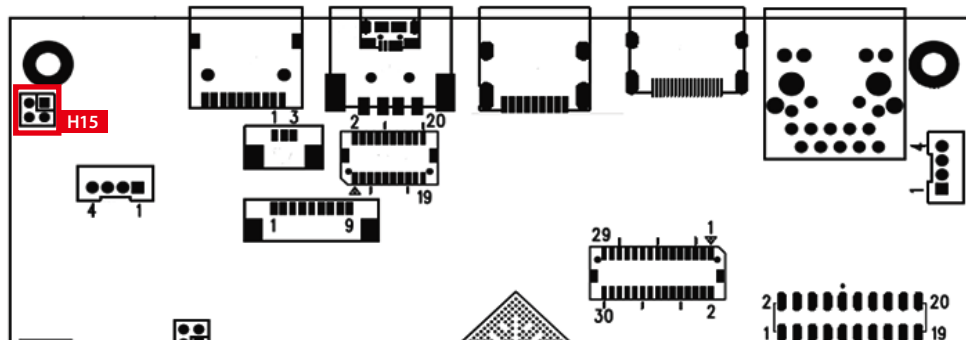

Short pin 1 and pin 2 of H15 to power up EIC-1000.

Pin Assignments of H15 are listed in the following table :

Pin No.	Status	Description
1-2	Open	Power off
	Close	Power on
3-4	Leave Open	For factory use only

### 2.4.4 W4 : Power Input

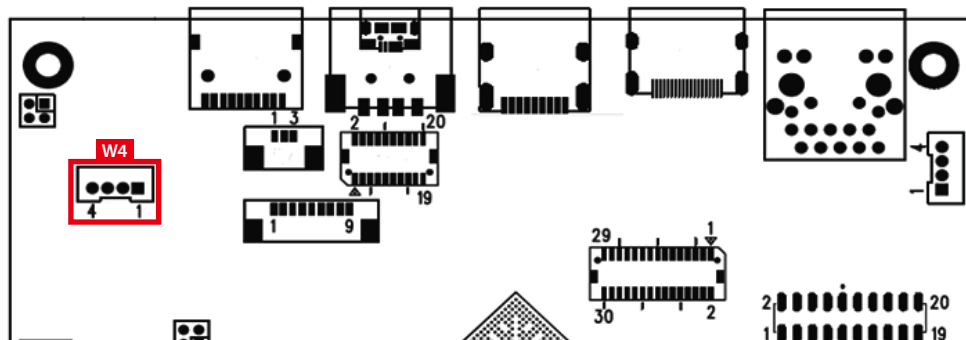

EIC-1000 MB supports 12V DC power input by wire-to-board connector in the top side. It is connected to the power board through W4 by cable.

Pin Assignments of W4 are listed in the following table :

Pin No.	Definition
1	GND
2	DC12V

## 2.4.5 W7 : Power Input

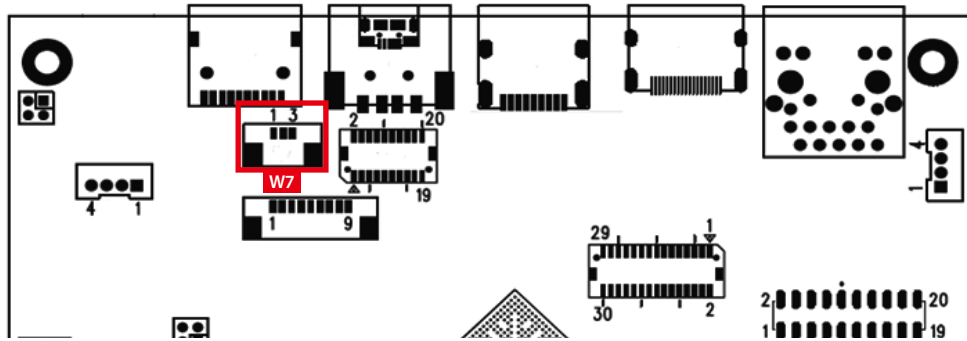

The blue LED indicates the system's power is plugged.  
Pin Assignments of W7 are listed in the following table :

Pin No.	Definition
1	Blue LED
2	GND
3	Reserved

## 2.4.6 W10 : USB Host, MEMS signals Connector

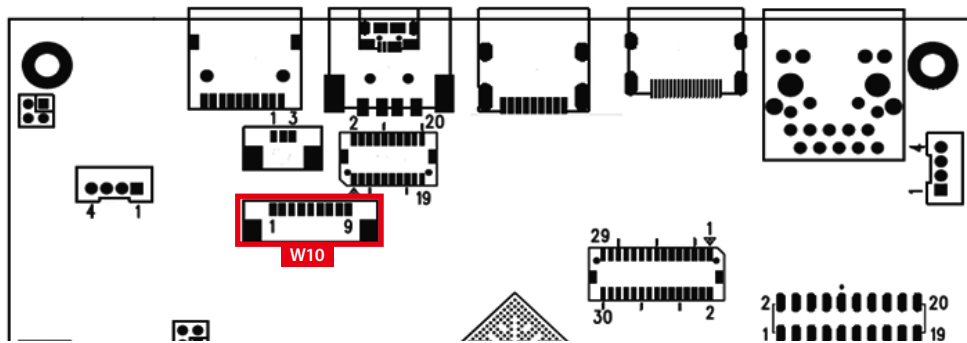

W10 supports USB 2.0 host or USB-MEMS application.  
Pin Assignments are listed in the following table :

Pin No.	Definition	Pin No.	Definition
1	LIGHT_INT_L (3.3V), Low active	2	GPIO (3.3V) Reserved
3	COMP_INT_L (3.3V), Low active	4	GSENSOR_INT_L (3.3V), Low active
5	GYR_INT_L (3.3V), Low active	6	USB_GND
7*	USB Data +	8	USB Data -
9	VBUS (+5V)		



## 2.4.7 W15 : I2C, SPI, ADC, GPIOs Connector

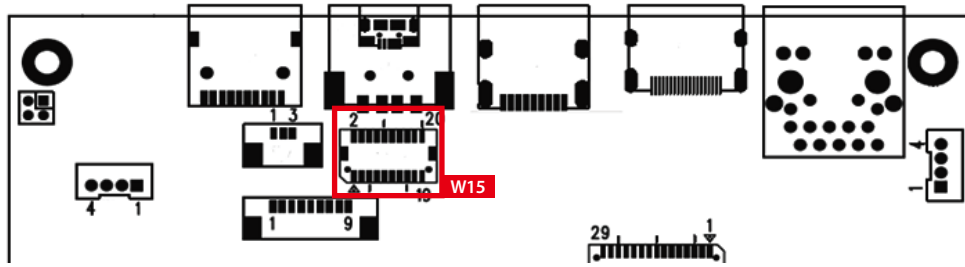

W15 provides non-isolated GPIOs with 4 GPI and 4 GPO signals, 2 I2C signals, 4 SPI signals, and 2 ADC signals.

For ADC signals, the maximum input voltage is 1.8V, 10-bit resolution,  $t_{CLK}=75ns$ , conversion time=  $13t_{CLK}$ , setup time= $0.5t_{CLK}$ .

Pin Assignments of W15 are listed in the following table :

Pin No.	Description	Pin No.	Description
1	DIN0, logical high level (3.3V)	2	DOUT0, logical high level (3.3V)
3	DIN1, logical high level (3.3V)	4	DOUT1, logical high level (3.3V)
5	DIN2, logical high level (3.3V)	6	DOUT2, logical high level (3.3V)
7	DIN3, logical high level (3.3V)	8	DOUT3, logical high level (3.3V)
9	GND	10	3.3V
11	SPI-3.3V-TXD	12	3.3V
13	SPI-3.3V-RXD	14	I2C4-3.3V-SDA
15	SPI-3.3V-CS	16	I2C4-3.3V-SCL
17	SPI-3.3V-CLK	18	ADC1-IN-1.8V
19	GND	20	ADC0-IN-1.8V

## 2.4.8 W12 : PoE Power Connector

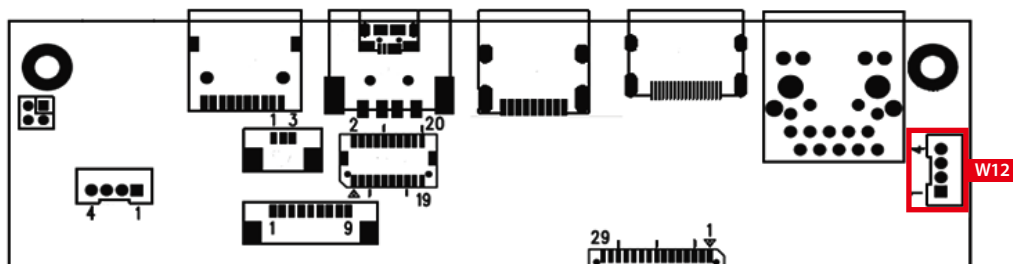

EIC-1000 supports optional PoE function for the Gigabit Ethernet on the front with Mode A and B. Mode A delivers power on the data pairs of Pin 1, 2, 3, 6. Mode B delivers power on the Pin 4, 5, 7, 8.

Pin Assignments of W12 are listed in the following table :

Pin No.	Description	Pin No.	Description
1	V+ (Mode A)	2	V-(Mode A)
3	V+ (Mode B)	4	V-(Mode B)

## 2.4.9 H10 : Audio Header

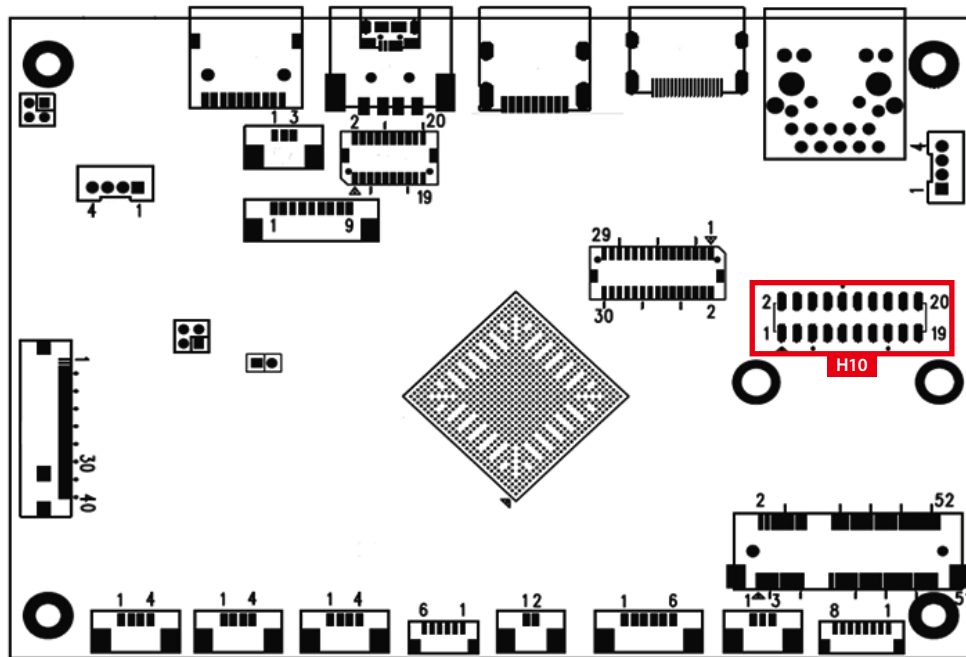

Onboard Realtek ALC5640 low power stereo codec supports speaker amplifiers 1.5W per channel into 8Ω or 2W per channel into 4Ω.

Pin Assignments of H10 are listed in the following table :

Pin No.	Description	Pin No.	Description
1	GND	2	HP_R
3	MIC_IN	4	HP_L
5	HP_GND	6	HP_detect
7	SPK_R-	8	SPK_R+
9	SPK_L-	10	SPK_L+
11	GND	12	GND
13	Stereo_MIC_R	14	Stereo_MIC_L
15	LINE_OUT_L	16	LINE_OUT_R
17	Reserved	18	GND
19	Reserved	20	Reserved

## 2.4.10 J9 : Mini PCIe

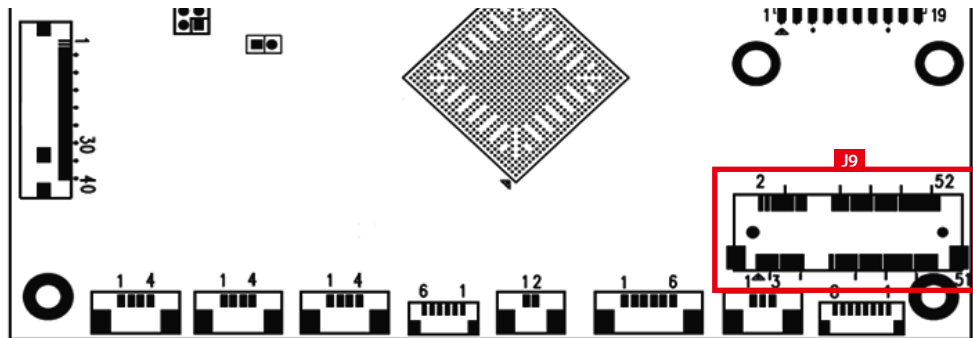

EIC-1000 has 1 standard half-size mini PCIe slot.

Pin Assignments of J9 are listed in the following table :

Pin No.	Definition	Pin No.	Definition
1	PCIe_Wake#	2	3.3V
3	NC	4	GND
5	NC	6	1.5V
7	NC	8	NC
9	GND	10	NC
11	PCIe_CREFCLKM	12	NC
13	PCIe_CREFCLKP	14	NC
15	GND	16	NC
17	NC	18	GND
19	NC	20	PCIe_DIS#
21	GND	22	PCIe_RST#
23	PCIe_CRXM	24	3.3V
25	PCIe_CRXP	26	GND
27	GND	28	1.5V
29	GND	30	PCIe_SMB_CLK
31	PCIe_CTXM	32	PCIe_SMB_DATA
33	PCIe_CTXP	34	GND
35	GND	36	PCIe_USB_DN
37	GND	38	PCIe_USB_DP
39	3.3V	40	GND
41	3.3V	42	LED_WWAN#
43	GND	44	LED_WLAN#
45	NC	46	LED_WPAN#
47	NC	48	1.5V
49	NC	50	GND
51	NC	52	3.3V

### 2.4.11 W8, W9, W18 : Internal USB 2.0 Connector

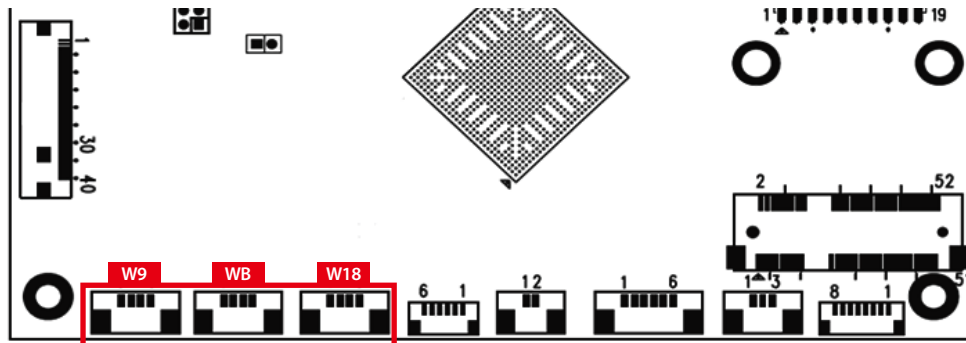

The internal USB 2.0 connectors provide extension to 3 more individual USB 2.0 ports. In addition, all of them feature hot plug capability.

Pin Assignments of W8, W9, W18 are listed in the following table :

Pin No.	Description	Pin No.	Definition
1	VBUS3 (+5V)	2	USB3 Data -
3	USB3 Data +	4	USB3_GND

### 2.4.12 W1 : RTC Battery

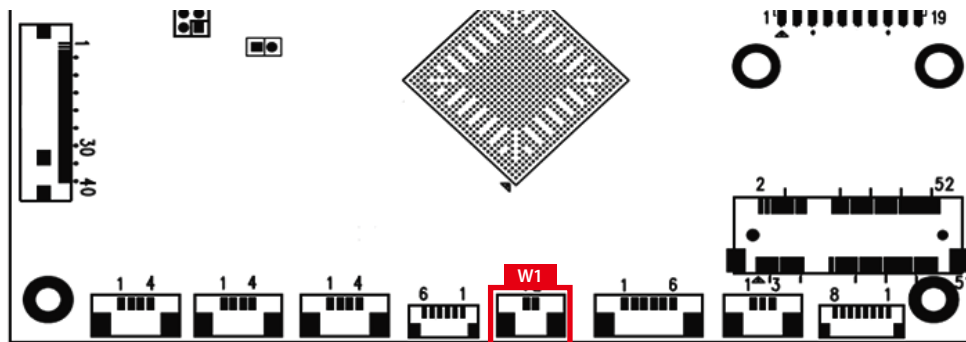

The system's real-time clock is powered by a lithium battery. It is equipped with Panasonic CR2032 190mAh lithium battery. It is not recommended that you replaced the lithium battery on your own. If the battery needs to be changed, please contact the Vecow RMA service team.

Pin Assignments of W1 are listed in the following table :

Pin No.	Definition
1	BAT+
2	BAT-

### 2.4.13 W17 : UART Connector

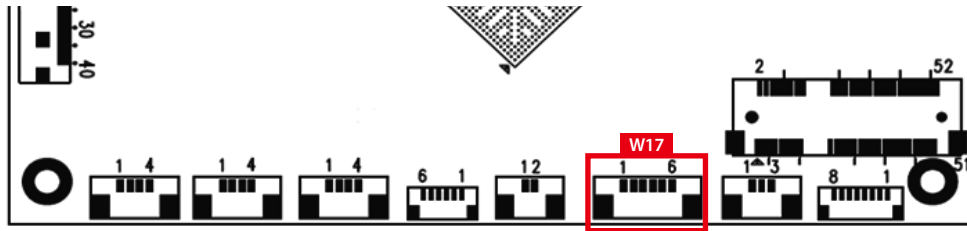

Pin Assignments of W17 are listed in the following table :

Pin No.	Description	Pin No.	Description
1	DC3.3V/60mA-Out	2	GND
3	UART-3.3V-RTS	4	UART-3.3V-CTS
5	UART-3.3V-TX (SOUT)	6	UART-3.3V-RX (SIN)

### 2.4.14 W20 : RS-232 Debug Connector

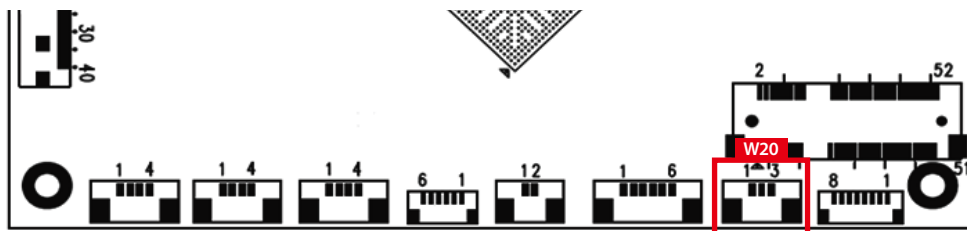

The debug port supports TX/RX with RS-232 level and it is only used for debugging purpose.

Pin Assignments of W20 are listed in the following table :

Pin No.	Description
1	Debug-RS232-RX (SIN)
2	Debug-RS232-TX (SOUT)
3	COM_GND

### 2.4.15 W19 : Reset, Wifi LEDs, Buzzer Combo Connector

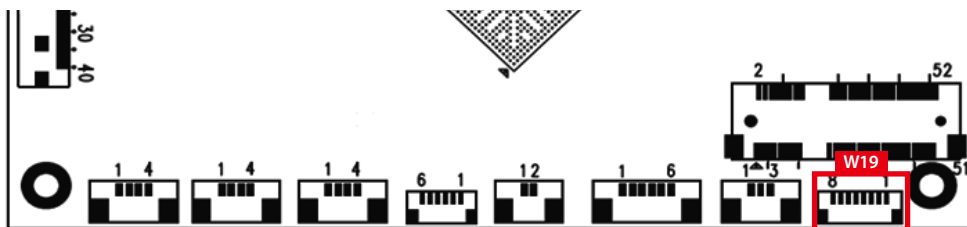

Pin Assignments of W19 are listed in the following table :

Pin No.	Description	Pin No.	Description
1	DC3.3V/25mA-Out	2	GND
3	Wifi LED: Out, Low active	4	BT LED: Out, Low active
5	Reset: In, Low active	6	GND
7	Buzzer-	8	Buzzer+

## 2.5 Expansion Board Connectors and Jumpers

### 2.5.1 Top View (Component Side) of SMX-300 with Connector Location

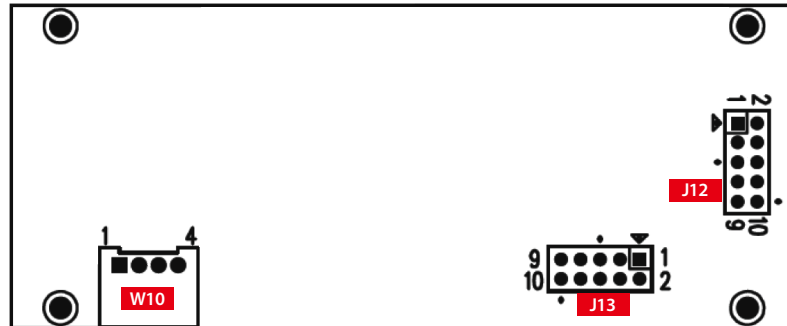

### 2.5.2 W10 : USB Input

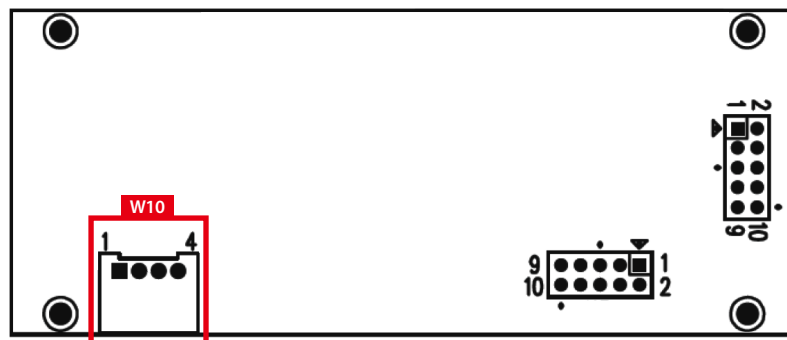

Pin Assignments of W10 are listed in the following table :

Pin No.	Definition	Pin No.	Description
1	USB-5V	2	USB-DM
3	USB-DP	4	GND

### 2.5.3 J12, J13 : RS-232/422/485 Serial Port

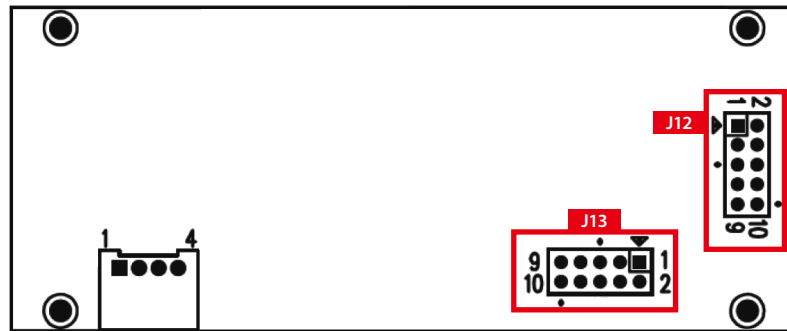

COM1 and COM2 can be configured for RS-232, RS-422, or RS-485. The default definition of COM 1 and COM 2 is RS-232. To change to RS-422 or RS-485, please refer to Section 4.4.

Pin Assignments of J12 and J13 are listed in the following table :

Serial Port	Pin No.	RS-232	RS-422	RS-485
1 to 2	1	DCD	TXD-	DATA-
	2	RXD	TXD+	DATA+
	3	TXD	RXD+	----
	4	DTR	RXD-	----
	5	GND	GND	GND
	6	DSR	----	----
	7	RTS	----	----
	8	CTS	----	----
	9	RI	----	----

# 3

## SYSTEM SETUP

### 3.1 How to Open Your EIC-1000

Remove eight pcs F-M3x4L screws and pick up top cover.

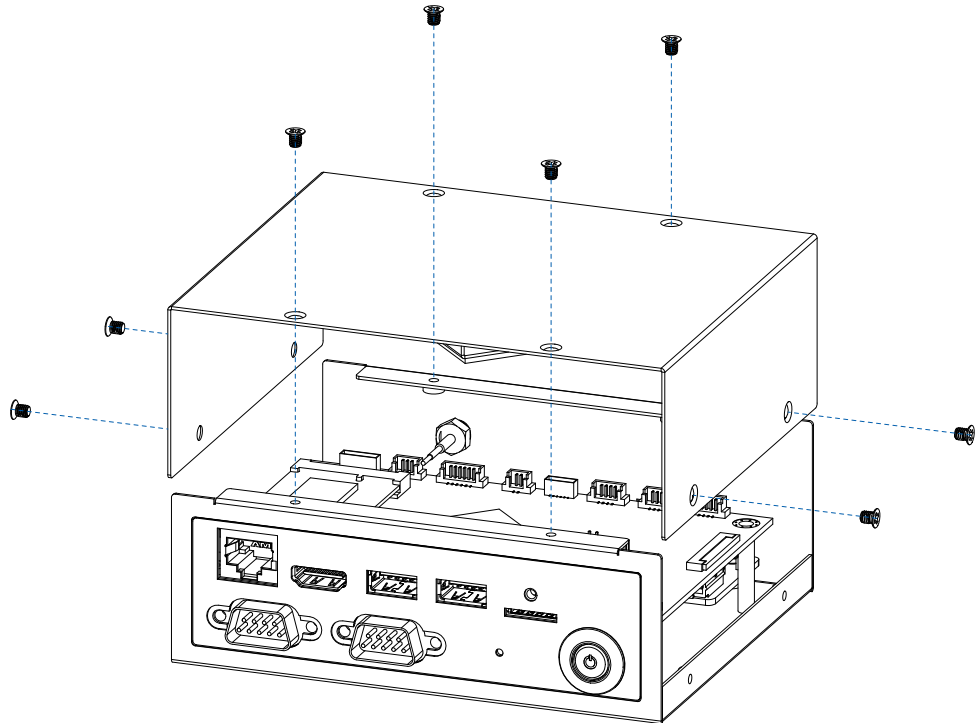



## 3.2 Installing SD Card

**Step 1** Remove one pcs PH-M3x4L screw and install SD Card.

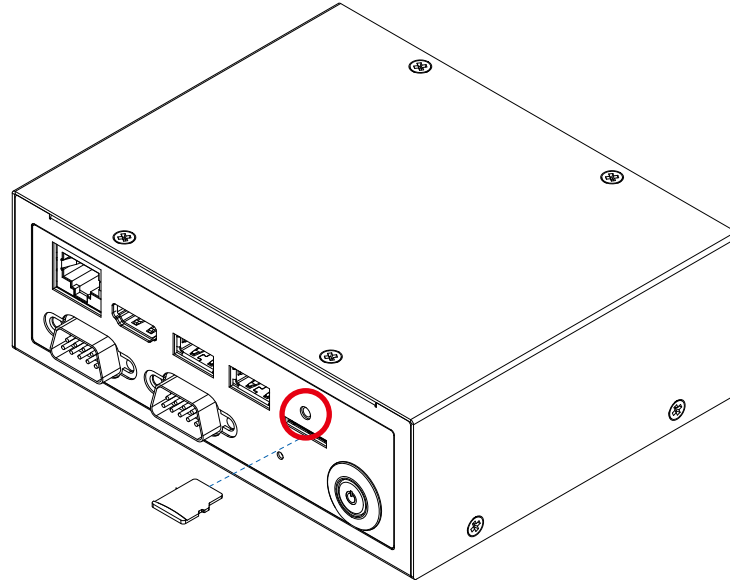

**Step 2** Install SD Cover on front panel.

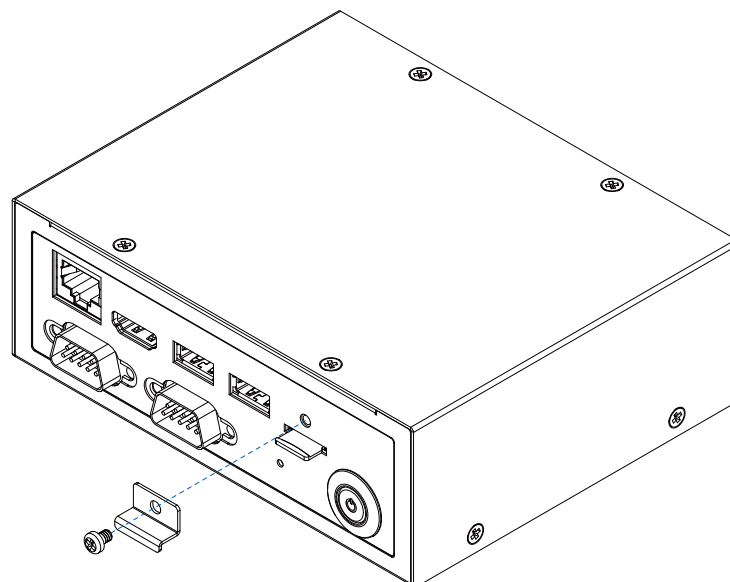

### 3.3 Installing Mini PCIe

Install MiniPCIe card into the Mini PCIe slot and fasten two PHILLPIS M2x4L screws.

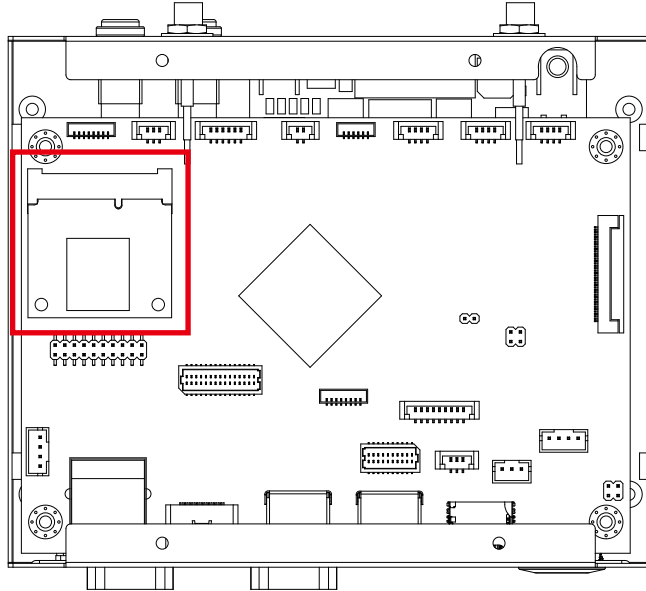

### 3.4 Installing Antenna Cable

**Step 1** Remove the rubber corks on the rear panel.

**Step 2** Put antenna cable connector into the hole on panel.

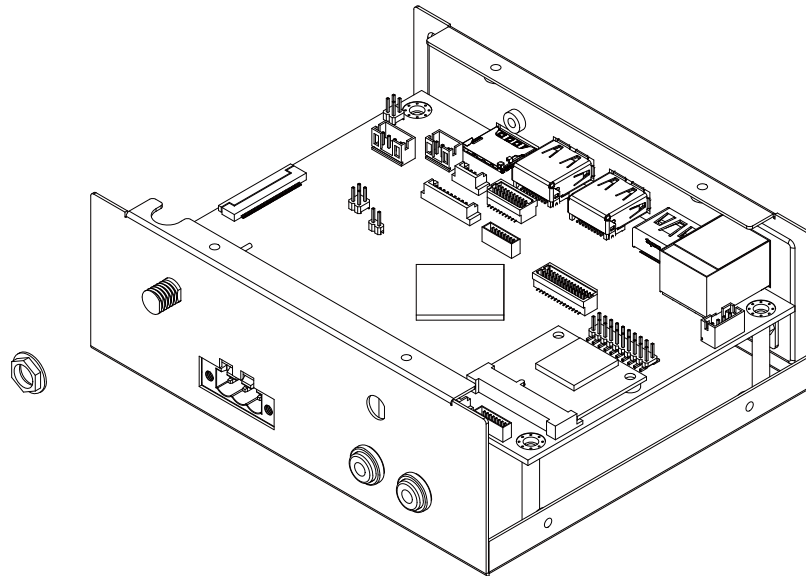

**Step 3** Fasten washer on the antenna cable connector.

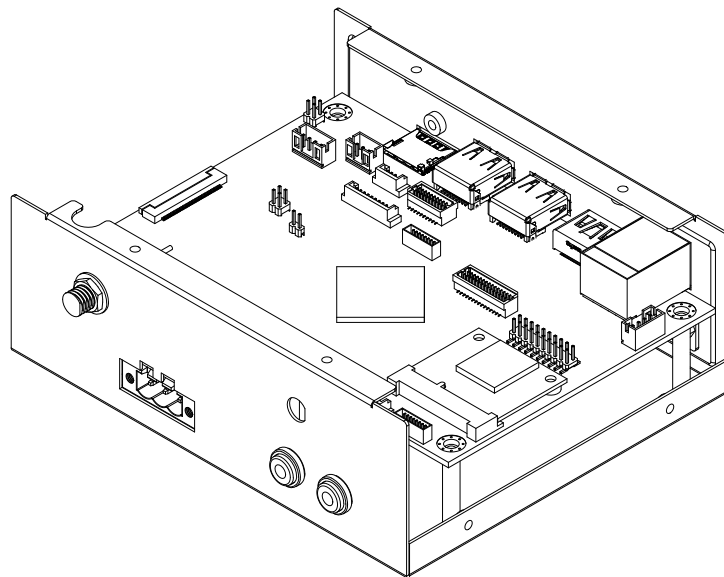

## 3.5 Mount Your EIC-1000

### Wall Mount

Install wall mount bracket then fasten four pcs F-M3x4L screws.

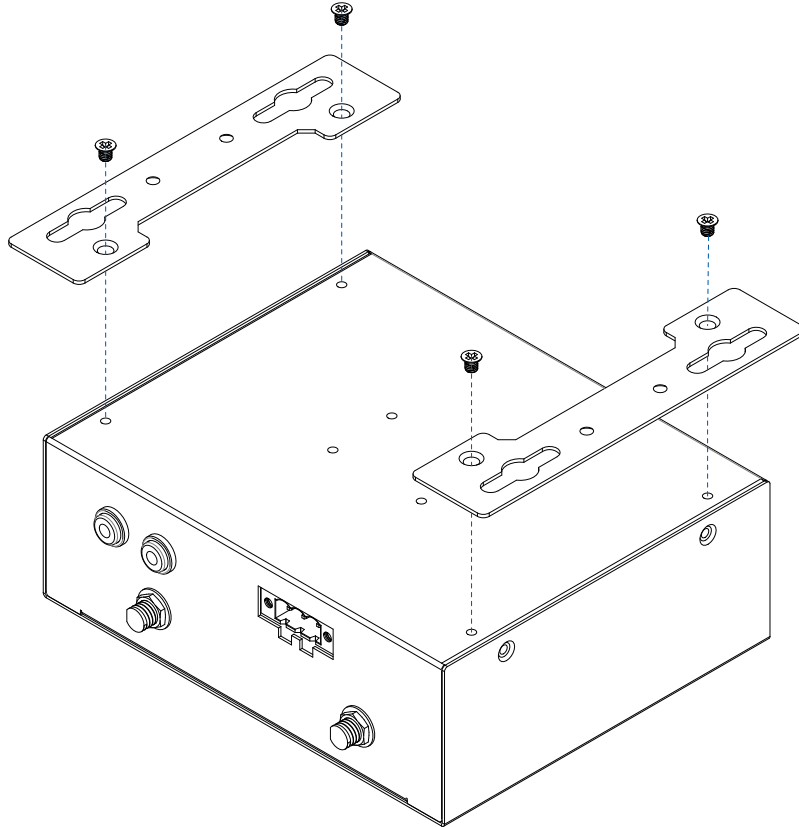

**Din Rail (The wall mount bracket must be installed first.)**

Install din rail kit then fasten screws.

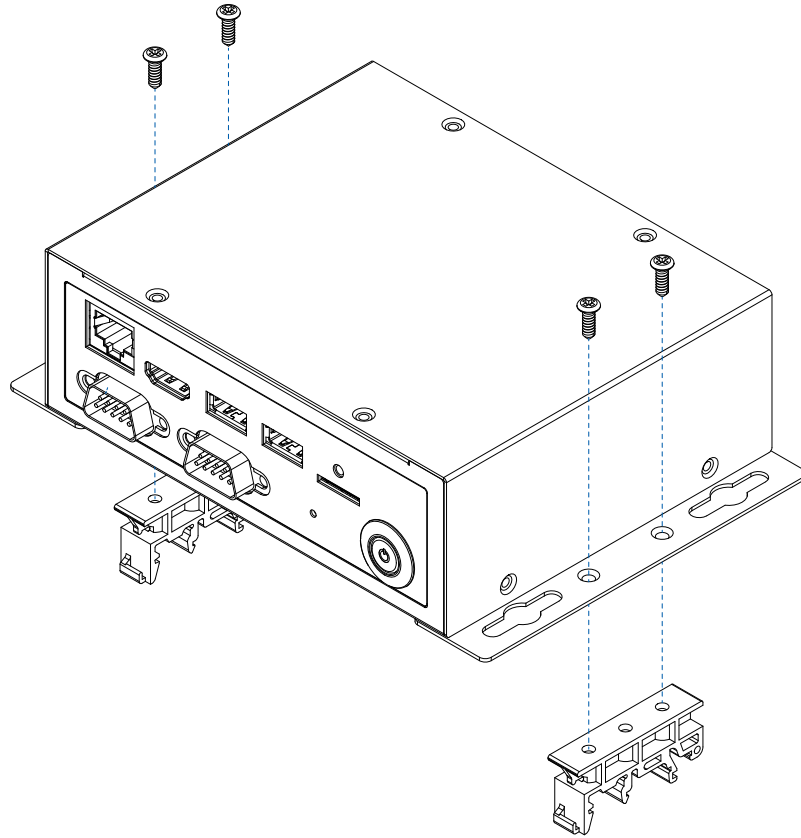

# 4

## SOFTWARE SETUP

### 4.1 Prerequisites

For Android C++ developer, please install termux (com.termux\_116.apk) software package (terminal). Download the package at <https://f-droid.org/en/packages/com.termux/>

You will find the "Termux" software icon shown as below after installation.

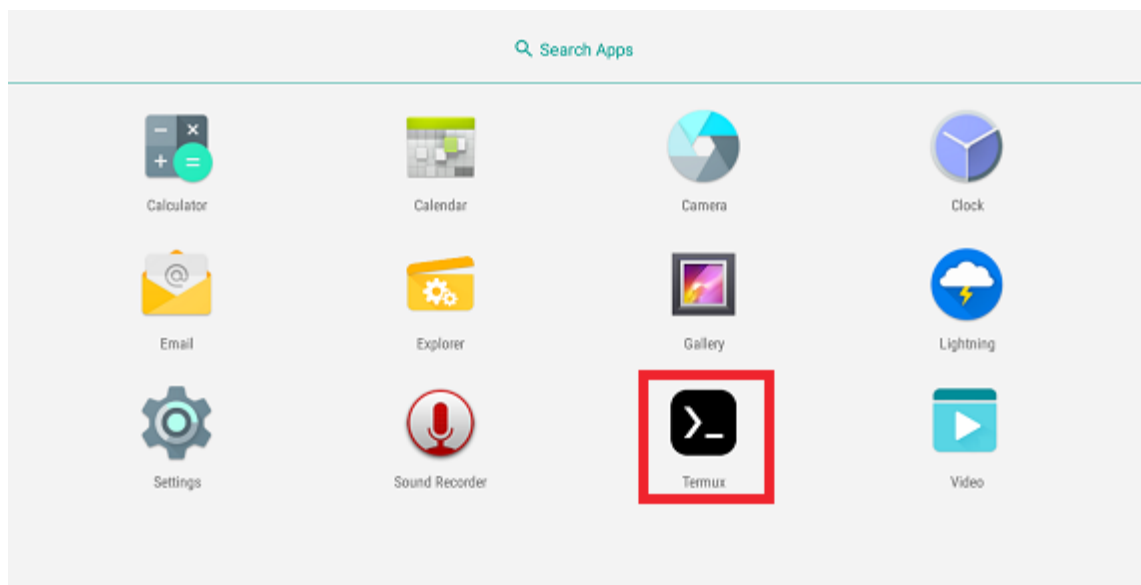

Termux has the same function as Linux terminal.

```
Subscribing to additional repositories:
* Root:   pkg install root-repo
* unstable: pkg install unstable-repo
* X11:    pkg install x11-repo

Report issues at https://termux.com/issues

The Google Play version of the Termux app no longer
receives updates. For more information, visit:
https://wiki.termux.com/wiki/Termux_Google_Play

$ ls
$ ls
$ pwd
/data/data/com.termux/files/home
$ ls /
acc default.prop          fstab rk30board.bootmode.nvme  init.debug.rc                init.rk30board.bootmode.nvme.rc  init.tablet.rc          mnt          sbin          sys
bugreports dev                       fstab rk30board.bootmode.unknown  init.envirom.rc              init.rk30board.bootmode.unknown.rc  init.usb.configfs.rc  oem          sdcard        system
cache  oemboot.ko                 init                               init.hostname.rc             init.rk30board.environment.rc      init.usb.rc            proc          seapp_contexts  ueventd.rc
charger  etc                          init.connectivity.rc          init.log-watch.rc            init.rk30board.rc               init.zygote32.rc       property_contexts  selinux_version  ueventd rk30board.rc
config  file_contexts.bin           init.coredump.rc              init.logs.rc                  init.rk30board.usb.rc            init.zygote64_32.rc   res              sepolicy        vendor
$      fstab rk30board          init.creablog.rc              init.rc                         init.rk30board.usb.rc            lib                 rk30xnanand_ko.ko  service_contexts  verity_key
data    file.rk30board.bootmode.emmc  init.debug-charging.rc        init.rk30board.bootmode.emmc.rc  init.rk30board.usb.rc            lib                 root               storage

$
```

Click the arrow to open the search app page.

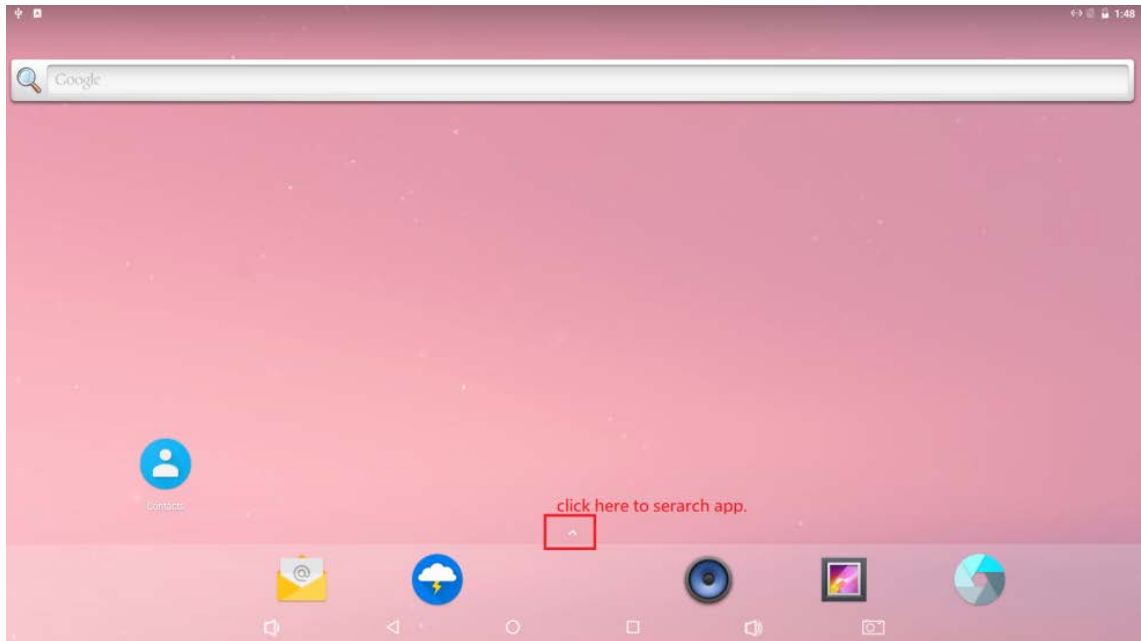

## 4.2 USB Debug Bridge

### 4.2.1 Android Debug Bridge (ADB)

The EIC-1000 USB 3.0 port is set as host mode in default. To use the ADB function, the USB 3.0 port must be set to device mode by following steps.

**Step 1** Enter Settings and select "About Tablet".

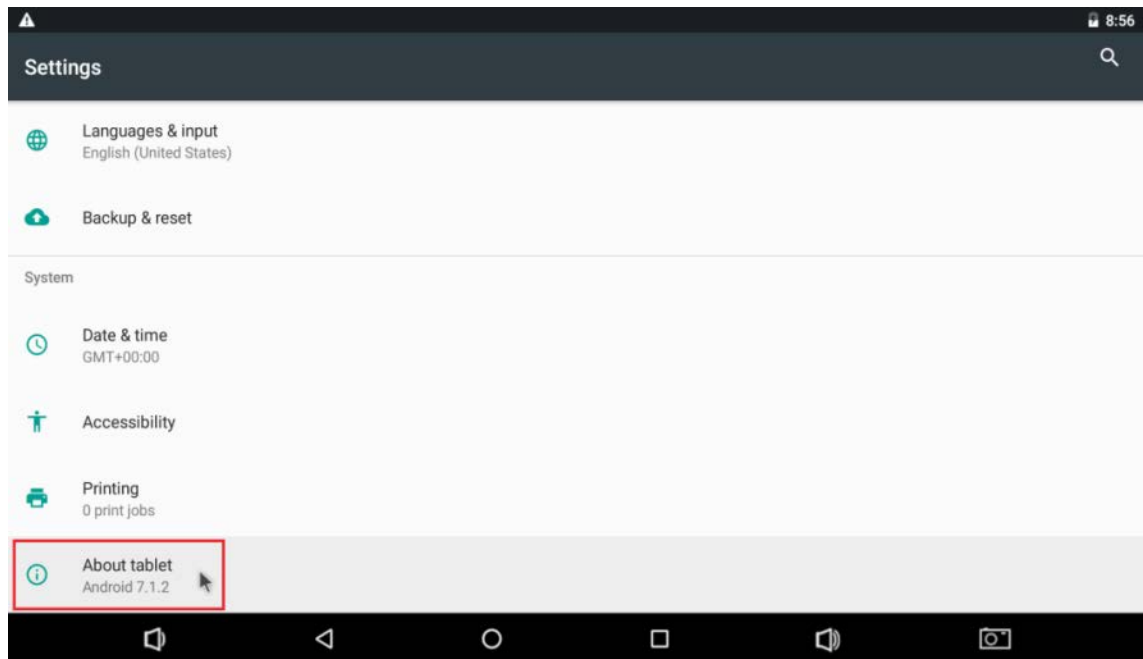

**Step 2** Click in the "Build number" in the dialog as shown. A countdown message will pop up. Keep clicking the click until the number counts to zero.

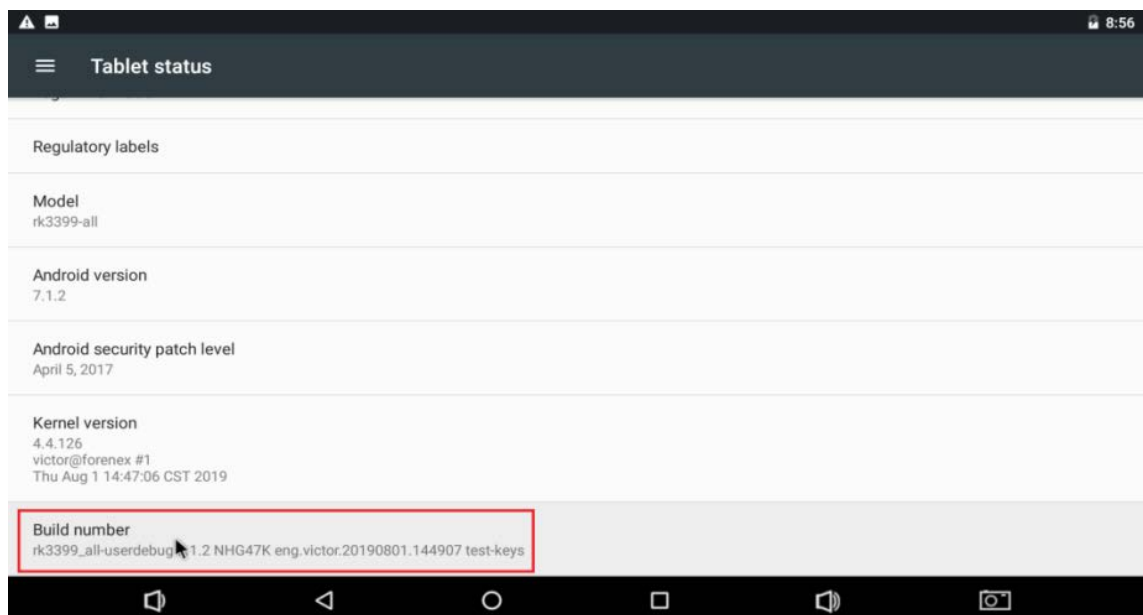



**Step 3** A new item "Developer Options" should appear in the system block.

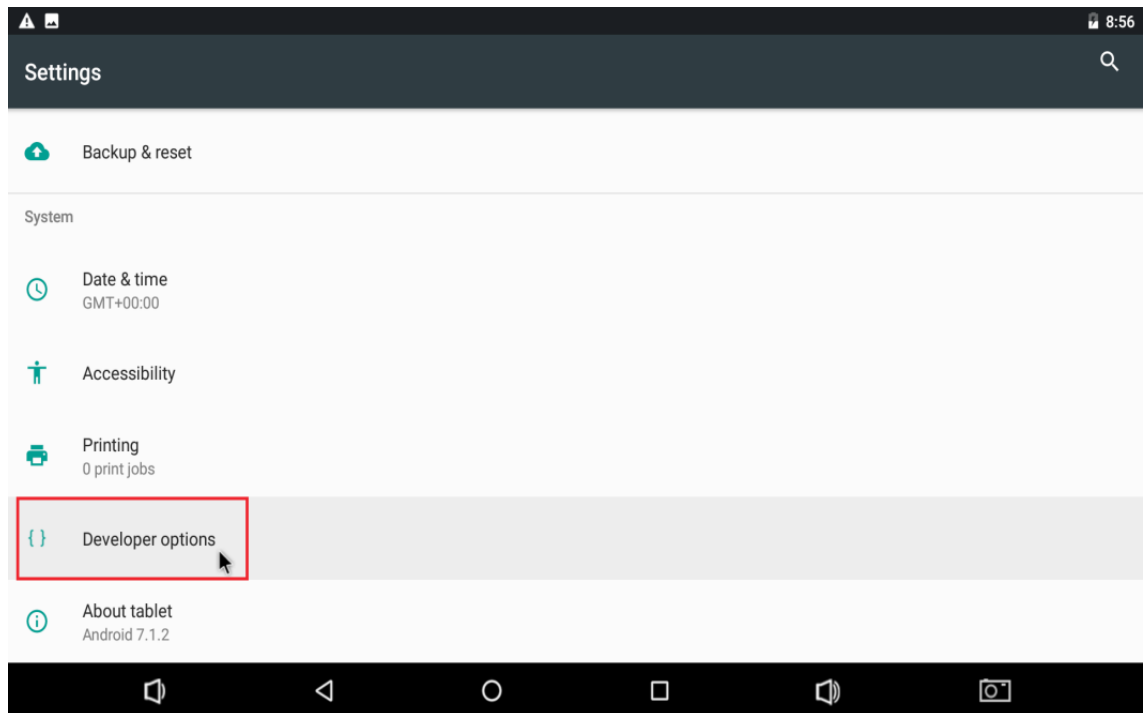

**Step 4** Select the "Developer Options" to turn on the USB debugging function.

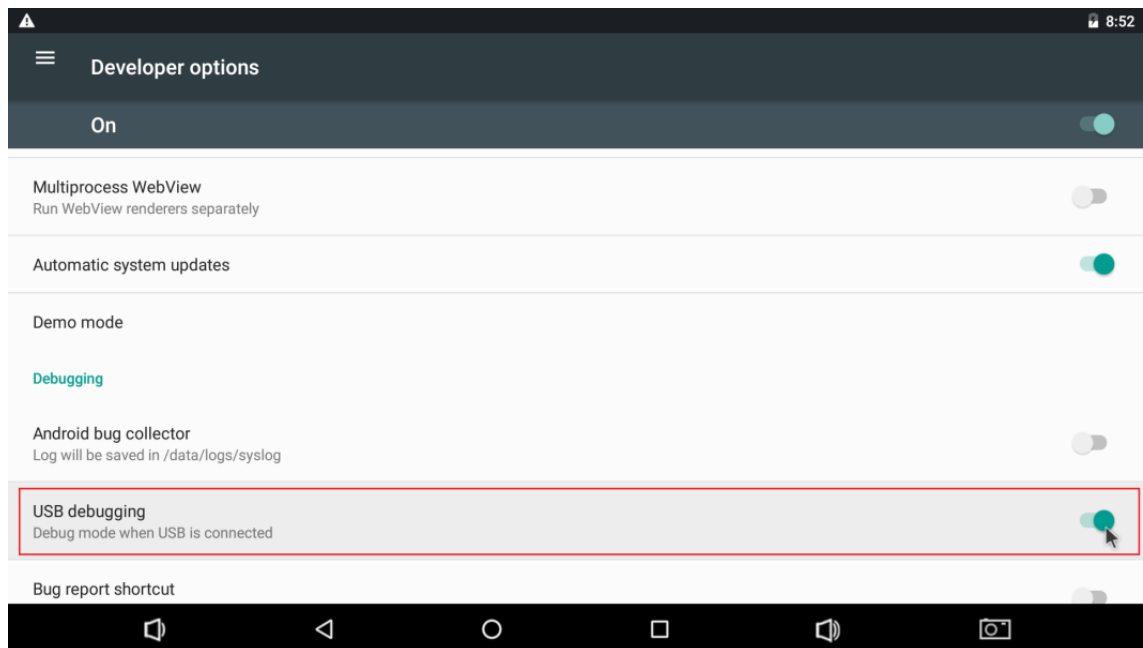

Note : Please do not change any others settings unless you know what you are doing.

**Step 5** Go back to Settings and select "USB".

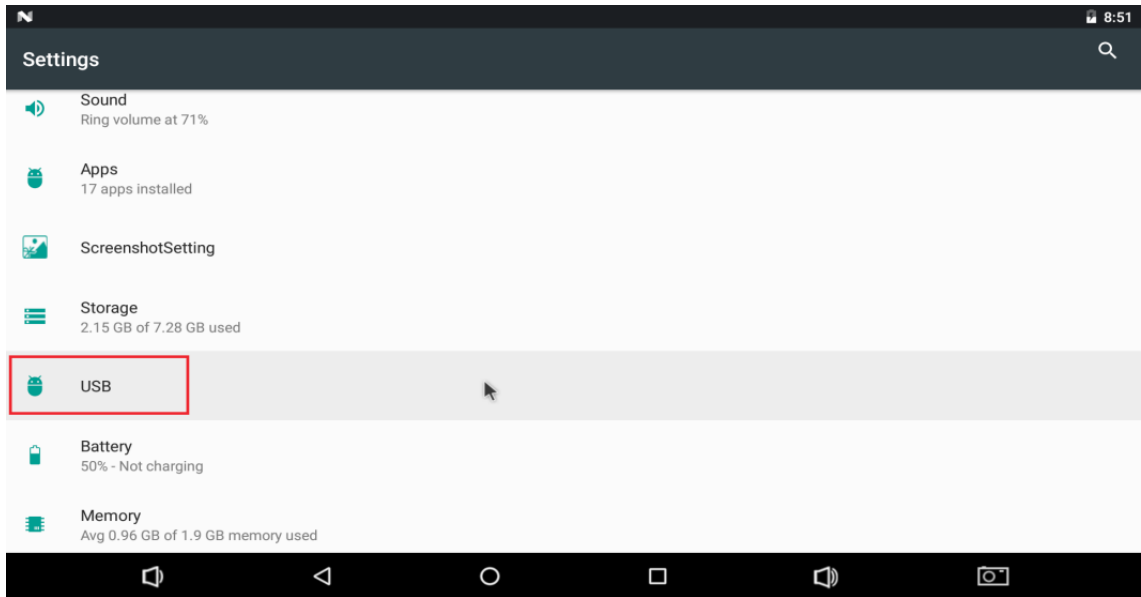

**Step 6** Select "ADB/HOST" and set USB 3.0 as ADB.

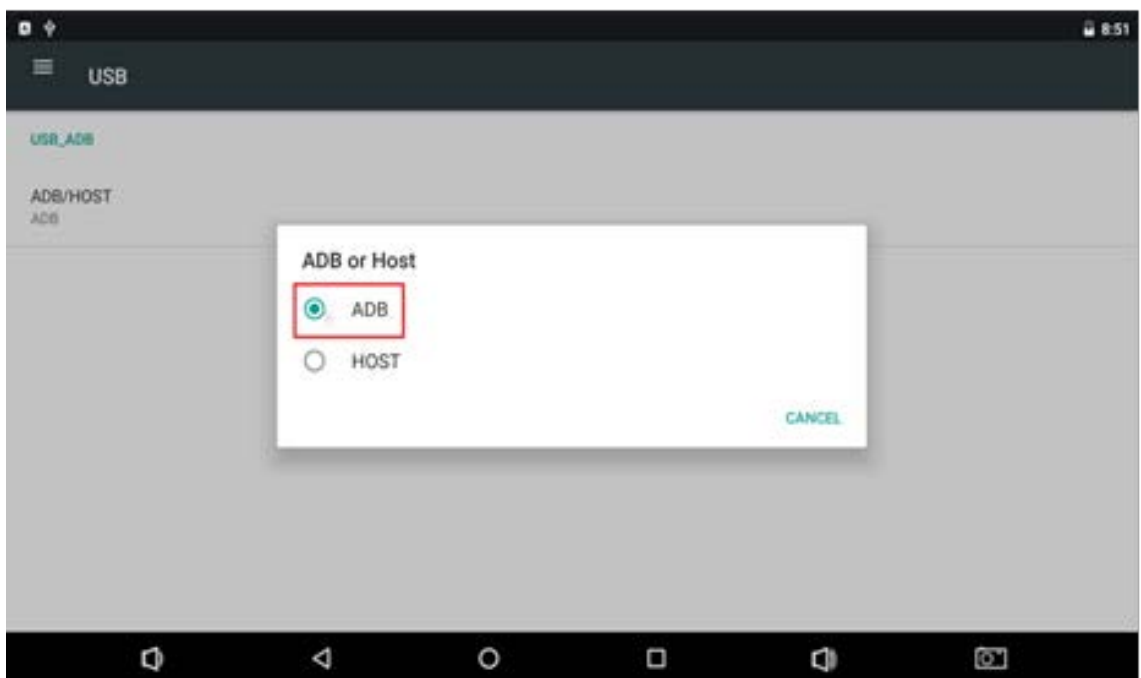

**Step 7** After the setting is complete, you can connect to a Windows PC through the USB 3.0 port and find the "Android ADB" Interface in the device manager.





## 4.2.2 Android APK Software Installation

**Step 1** To install APK software, you can use the built-in "apkinstaller" App or through USB. Please download the "Android Tool" Software Package at <https://www.t-firefly.com/doc/download/53.html>

A product page for the ROC-RK3399-PC. On the left is an image of a small, dark-colored circuit board. To the right, the product name 'ROC-RK3399-PC' is displayed in orange, with 'Specs' and 'Buy' buttons. Below the name is a descriptive paragraph: 'Unique multiple power supply mode and unique plate design. It can be connected to the expansion board, making the performance stronger and superior. When combined with the metal casing, it becomes a pocket portable personal computer.'

<p><b>Tools</b></p> <ul style="list-style-type: none"> <li>Driver Assistant (common) 2017-07-25</li> <li>SD_Firmware_Tool 2019-01-08</li> <li style="border: 2px solid red; padding: 2px;">AndroidTool 2020-09-11</li> <li>firefly-linux-repack (linux) 2021-01-09</li> </ul>	<p><b>Source Codes</b></p> <ul style="list-style-type: none"> <li>Android 7.1 SDK Source (common) 2017-08-31</li> <li>Android 7.1 SDK Source(Industry common) Major Maintenance 2019-12-18</li> <li>Linux_SDK (Support RK3399) 2019-02-18</li> </ul>
---	--

## Step 2 Connect the EIC-1000 USB 3.0 port with Windows PC.

 adb	2014/1/17 下午 0...	應用程式	800 KB
 AdbWinApi.dll	2014/1/17 下午 0...	應用程式擴充	94 KB
 AdbWinUsbApi.dll	2014/1/17 下午 0...	應用程式擴充	60 KB
 AFPTool	2013/3/20 下午 0...	應用程式	172 KB
 RKImageMaker	2012/11/7 上午 1...	應用程式	208 KB

## Step 3 Begin APK software installation through Window PC command prompt.

```
adb install xxxxx.apk
```

cmd

```
Microsoft Windows [Version 10.0.17763.2268]
(c) 2018 Microsoft Corporation. All rights reserved.

C:\Users\Chris>cd\

C:\>adb install xxxxx.apk
```

Enter Terminal Mode: `$adb shell`

Exit Terminal Mode: `$exit`

```
cmd -adb shell
RKImageMaker.exe
5 File(s) 1,365,504 bytes
2 Dir(s) 246,621,687,808 bytes free

D:\Vecow_Standard_Project\EIC-1000_1080P_Image\1920x1080_AIOT_32G_debian_image\AndroidTool_Release\bin>adb shell
rk3399_all:/ $ ls
ls
acct                init.rk30board.rc
bugreports          init.rk30board.usb.rc
cache               init.rk3399.rc
charger             init.rockchip.rc
config              init.tablet.rc
d                   init.usb.configfs.rc
data                init.usb.rc
default.prop        init.zygote32.rc
dev                 init.zygote64_32.rc
drmboot.ko          lib
etc                 metadata
file_contexts.bin  mnt
fstab.rk30board     oem
fstab.rk30board.bootmode.emmc  proc
fstab.rk30board.bootmode.nvme  property_contexts
fstab.rk30board.bootmode.unknown  res
init                rk30xxnand_ko.ko
init.connectivity.rc  root
init.coredump.rc     sbin
init.crashlogd.rc    sdcard
init.debug-charging.rc  seapp_contexts
init.debug.rc        selinux_version
init.environ.rc      sepolicy
```

Shutdown System: `$reboot -p`

Reboot System: `$reboot`

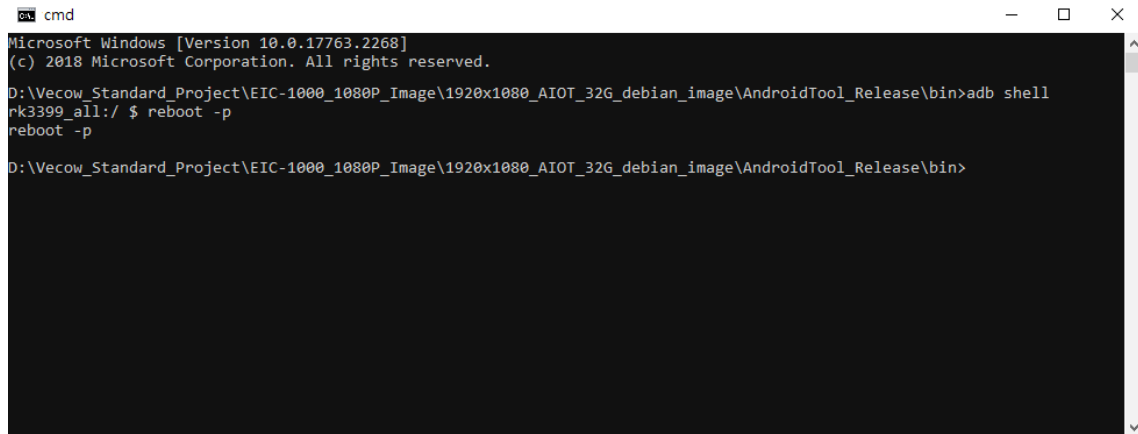

```
cmd
Microsoft Windows [Version 10.0.17763.2268]
(c) 2018 Microsoft Corporation. All rights reserved.

D:\Vecow_Standard_Project\EIC-1000_1080P_Image\1920x1080_AIOT_32G_debian_image\AndroidTool_Release\bin>adb shell
rk3399_all:/ $ reboot -p
reboot -p

D:\Vecow_Standard_Project\EIC-1000_1080P_Image\1920x1080_AIOT_32G_debian_image\AndroidTool_Release\bin>
```

### 4.2.3 Linux Debug Console

**Step 1** Install SSH service.

```
$sudo apt-get install sshd
```

**Step 2** Active SSH service.

```
sudo service sshd start
```

**Step 3** Check SSH service status.

```
sudo service sshd status
```

**Step 4** If installed successfully, the systems will response as below.

```
Active: active (running) since Sun 20xx-xx-xx xx:xx:xx CST; 15s ago
```

## 4.3 GPIO

### 4.3.1 GPIO List

Position	PIN name	Linux node/Note	Direction
PIN 1	DIN2	/sys/class/gpio/gpio76/value	In
PIN 2	DOUT2	/sys/class/gpio/gpio69/value	Out
PIN 3	DIN0	/sys/class/gpio/gpio74/value	In
PIN 4	DOUT1	/sys/class/gpio/gpio68/value	Out
PIN 5	DIN1	/sys/class/gpio/gpio73/value	In
PIN 6	DOUT3	/sys/class/gpio/gpio67/value	Out
PIN 7	DIN3	/sys/class/gpio/gpio70/value	In
PIN 8	DOUT0	/sys/class/gpio/gpio66/value	Out
PIN 9	Ground		
PIN 10	3.3V	Power supply	Out

### 4.3.2 GPIOs control method

You can write or read value by The GPIOs with the Linux command echo/cat by debug port.

```
linaro@linaro-alip:~$ sudo -s
root@linaro-alip:/home/linaro# echo 1 > /sys/class/gpio/gpio69/value
root@linaro-alip:/home/linaro# cat /sys/class/gpio/gpio69/value
1
root@linaro-alip:/home/linaro# echo 0 > /sys/class/gpio/gpio69/value
root@linaro-alip:/home/linaro# cat /sys/class/gpio/gpio69/value
0
root@linaro-alip:/home/linaro#
```

For Android, please use the following adb.exe command.

```
cmd - adb shell
D:\Vecow_Standard_Project\EIC-1000_1080P_Image\1920x1080_AIOT_32G_debian_image\AndroidTool_Release\bin>adb shell
rk3399_all:/ $ echo 1 > /sys/class/gpio/gpio69/value
echo 1 > /sys/class/gpio/gpio69/value
rk3399_all:/ $
```

## 4.4 Serial Port

### 4.4.1 Linux Serial Port

The serial port is set to RS-232 mode in default. To switch to RS-422 or RS-485 mode, please follow the following steps.

#### Step 1 Install gcc compiler

```
$ sudo apt-get install gcc
```

#### Step 2 Enter command for compiler

```
$gcc -fPIC -static main.c FR2ur2_comport.c -o set_mode
```

#### Step 3 Switch to RS-232

```
$/set_mode /ttyUSB0 1
```

#### Step 4-1 Switch to RS-485

```
$/set_mode /ttyUSB0 2 (sender)
```

```
$/set_mode /ttyUSB0 3 (receiver)
```

#### Step 4-2 Switch to RS-422

```
$/set_mode /ttyUSB0 0
```

### 4.4.2 Android Serial Port

#### Step 1 Enter the following adb.exe command.

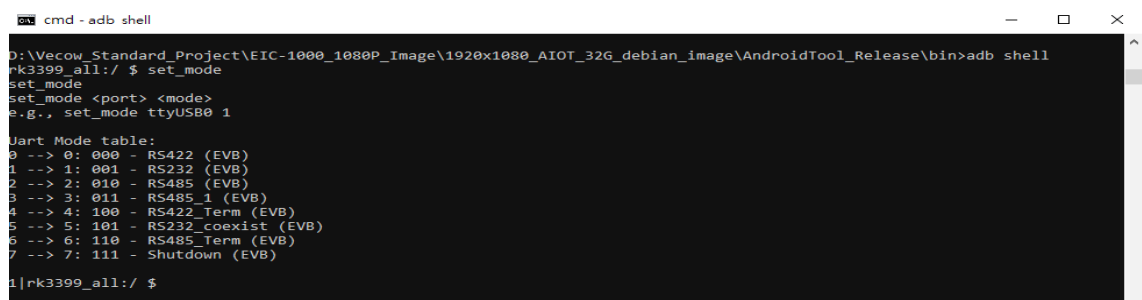

```
cmd - adb shell
D:\Vecow_Standard_Project\EIC-1000_1080P_Image\1920x1080_AIOT_32G_debian_image\AndroidTool_Release\bin>adb shell
rk3399_all:/ $ set_mode
set_mode
set_mode <port> <mode>
e.g., set_mode ttyUSB0 1

uart Mode table:
0 --> 0: 000 - RS422 (EVB)
1 --> 1: 001 - RS232 (EVB)
2 --> 2: 010 - RS485 (EVB)
3 --> 3: 011 - RS485_1 (EVB)
4 --> 4: 100 - RS422_Term (EVB)
5 --> 5: 101 - RS232_coexist (EVB)
6 --> 6: 110 - RS485_Term (EVB)
7 --> 7: 111 - Shutdown (EVB)

a|rk3399_all:/ $
```

#### Step 2 Enter serial port read/write test command.

```
$ read -t 3 serialport1 < /dev/ttyUSB1
```

```
$ echo "serial port test" > /dev/ttyUSB1
```

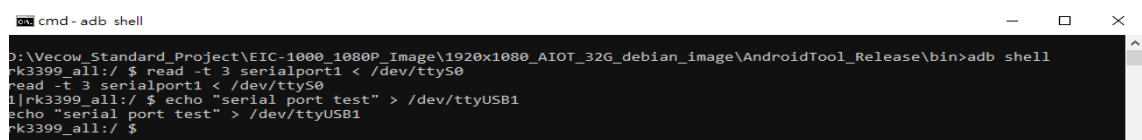

```
cmd - adb shell
D:\Vecow_Standard_Project\EIC-1000_1080P_Image\1920x1080_AIOT_32G_debian_image\AndroidTool_Release\bin>adb shell
rk3399_all:/ $ read -t 3 serialport1 < /dev/ttyUSB0
read -t 3 serialport1 < /dev/ttyUSB0
a|rk3399_all:/ $ echo "serial port test" > /dev/ttyUSB1
echo "serial port test" > /dev/ttyUSB1
rk3399_all:/ $
```

## 4.5 Ethernet

**Step 1** Enter setting and select "More" in the wireless & networks section.



**Step 2** Select Ethernet.

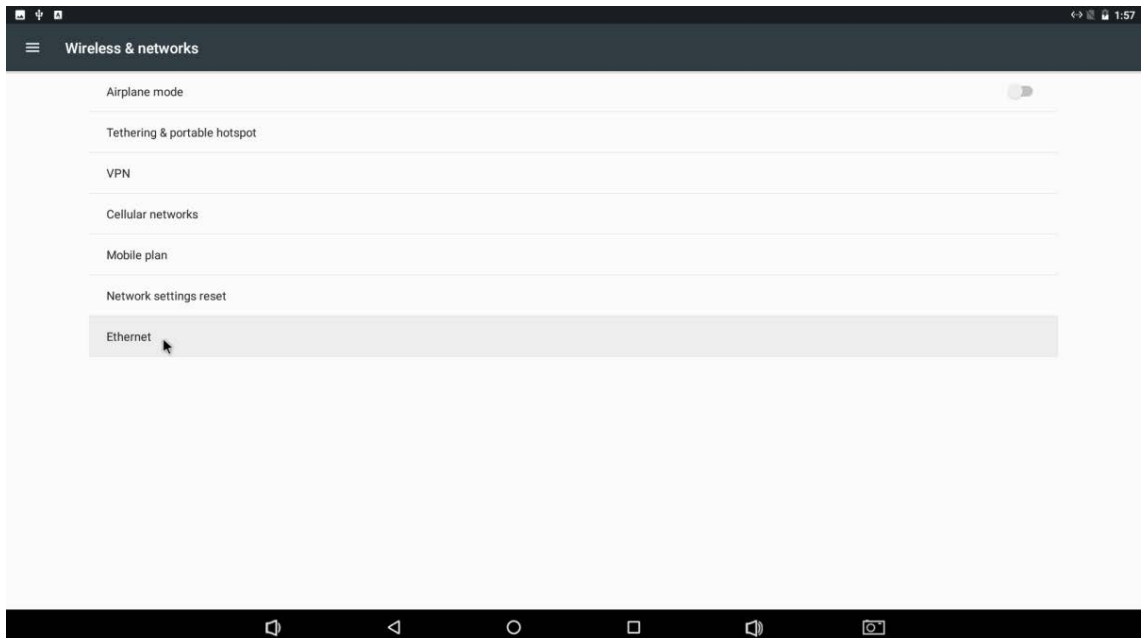



### Step 3 Edit Ethernet settings.

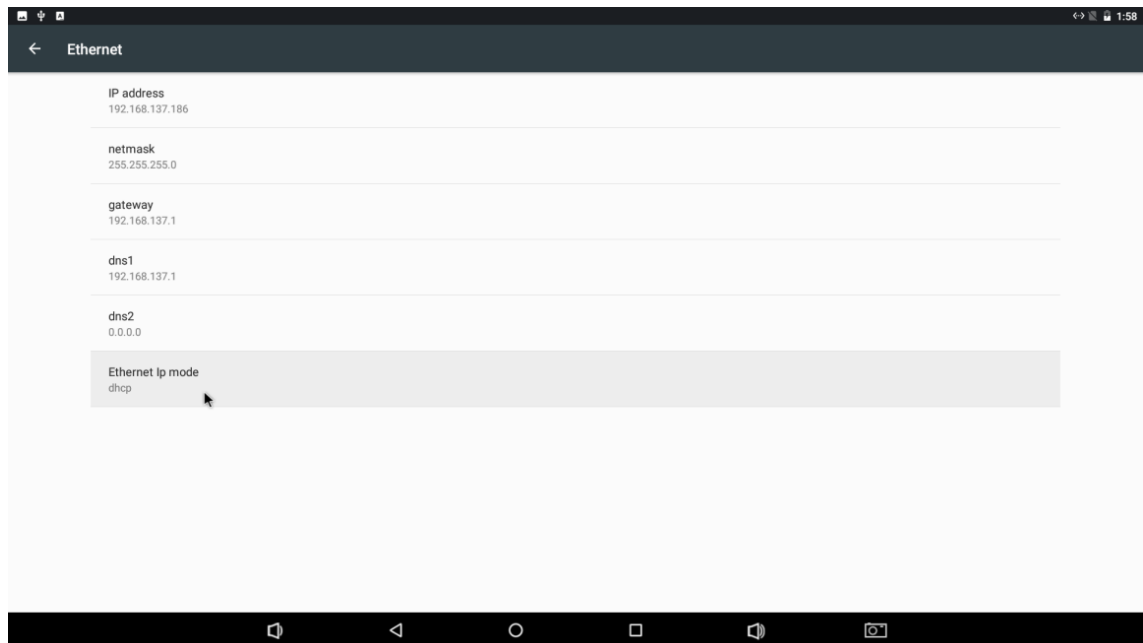

## 4.6 Camera

EIC-1000 supports USB Web CAM, you can use the built-in camera software for the camera functions.

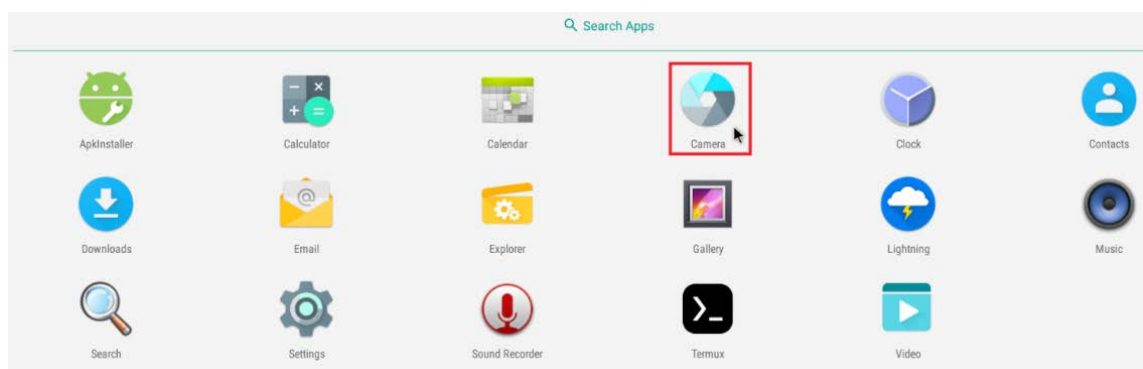

## 4.7 Storage

### 4.7.1 USB Storage

**Step 1** Click the upper-left icon on the desktop.

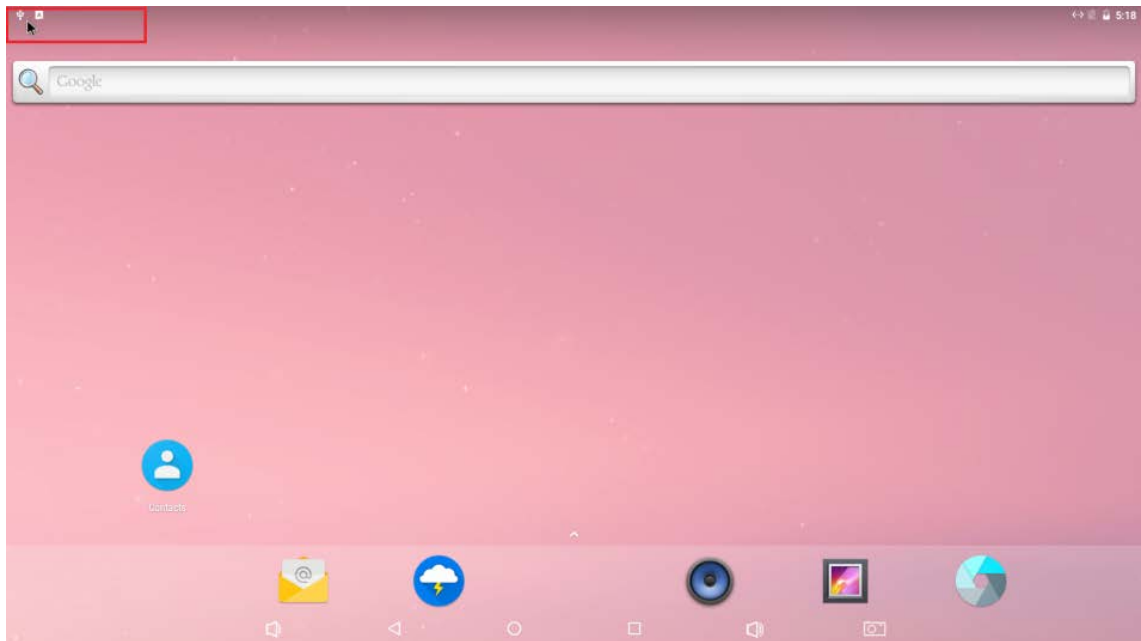

**Step 2** Click "Explore" to open file manager.

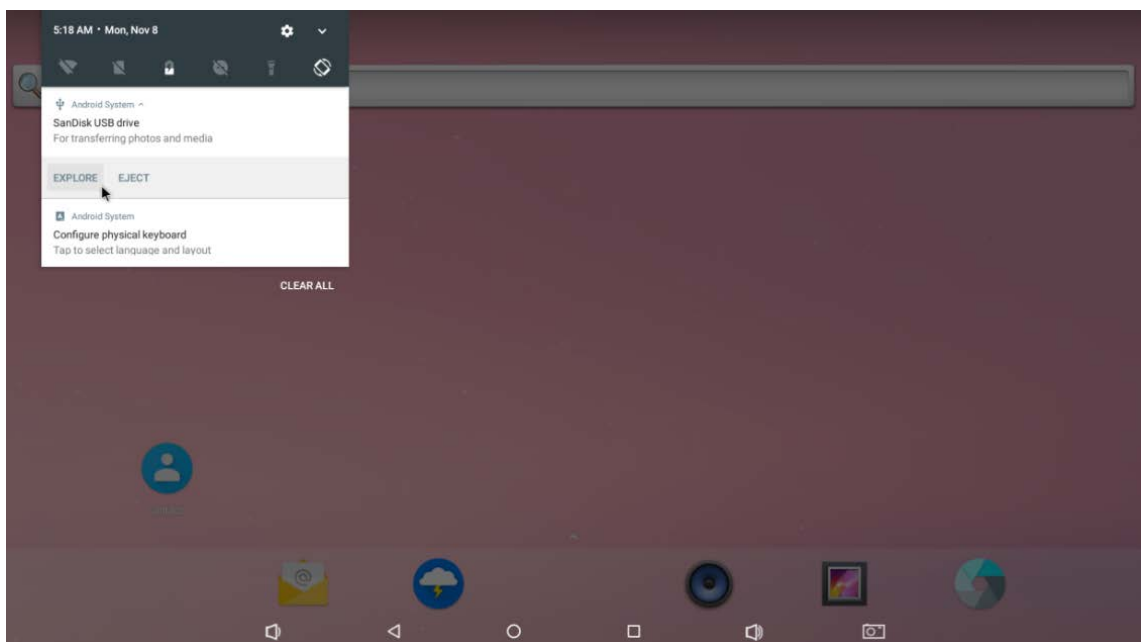

**Step 3** Click the corresponding device icon to access the files.

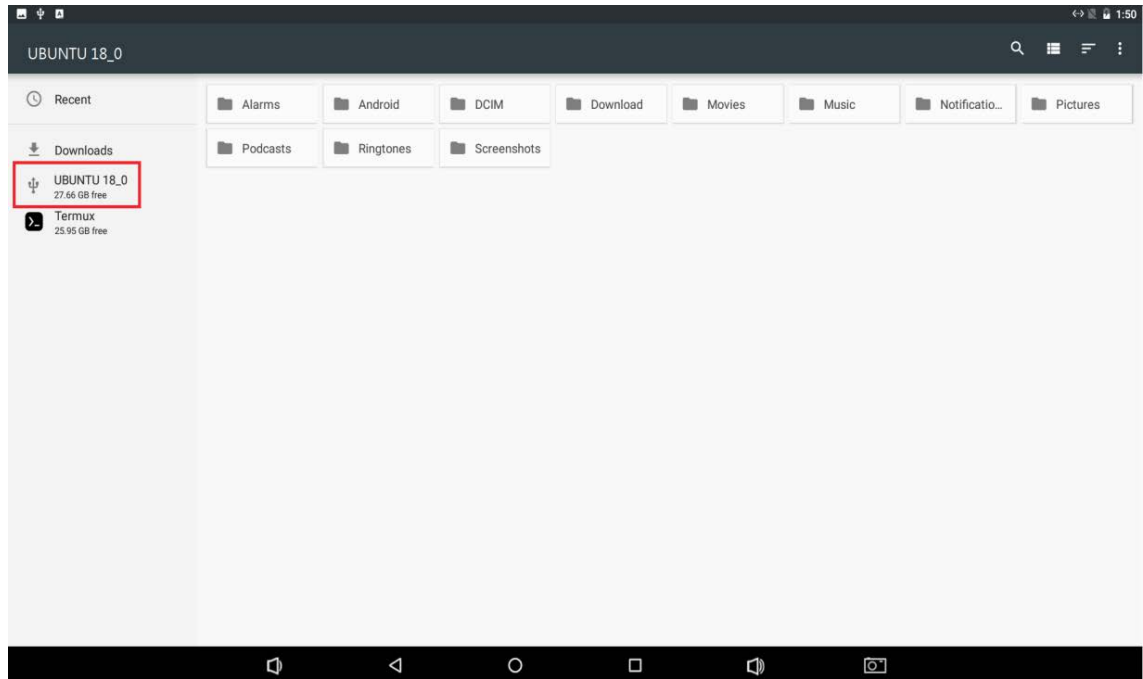

## 4.7.2 Internal Storage (eMMC)

**Step 1** Click the upper-left icon on the desktop.

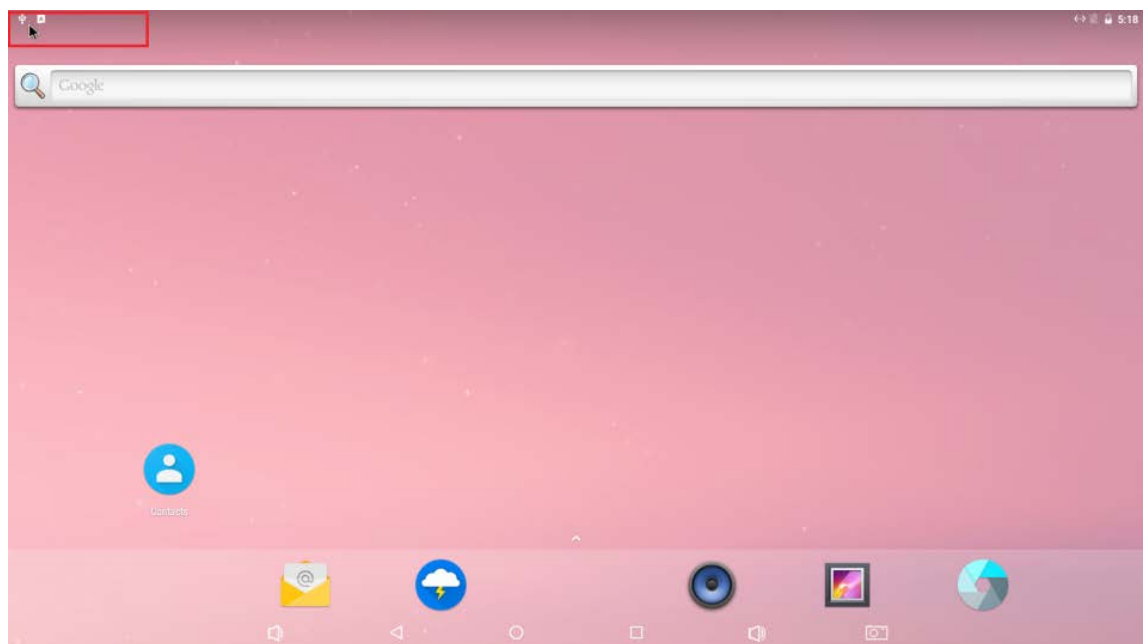

**Step 2** Click "Explore" to open file manager.

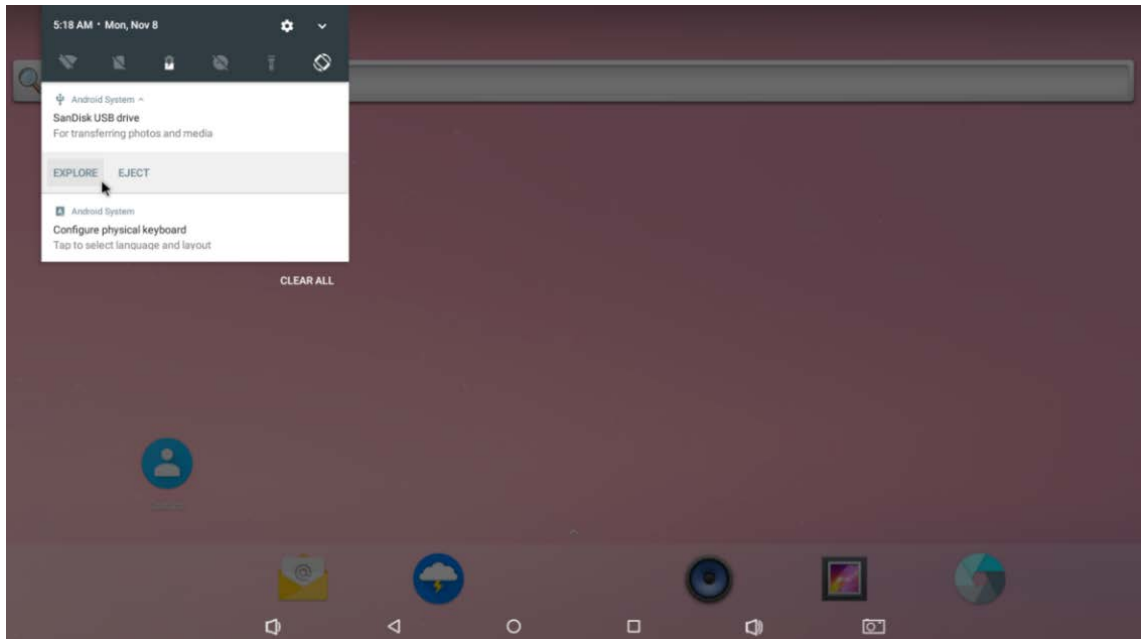

**Step 3** Right click and select "Show internal storage"

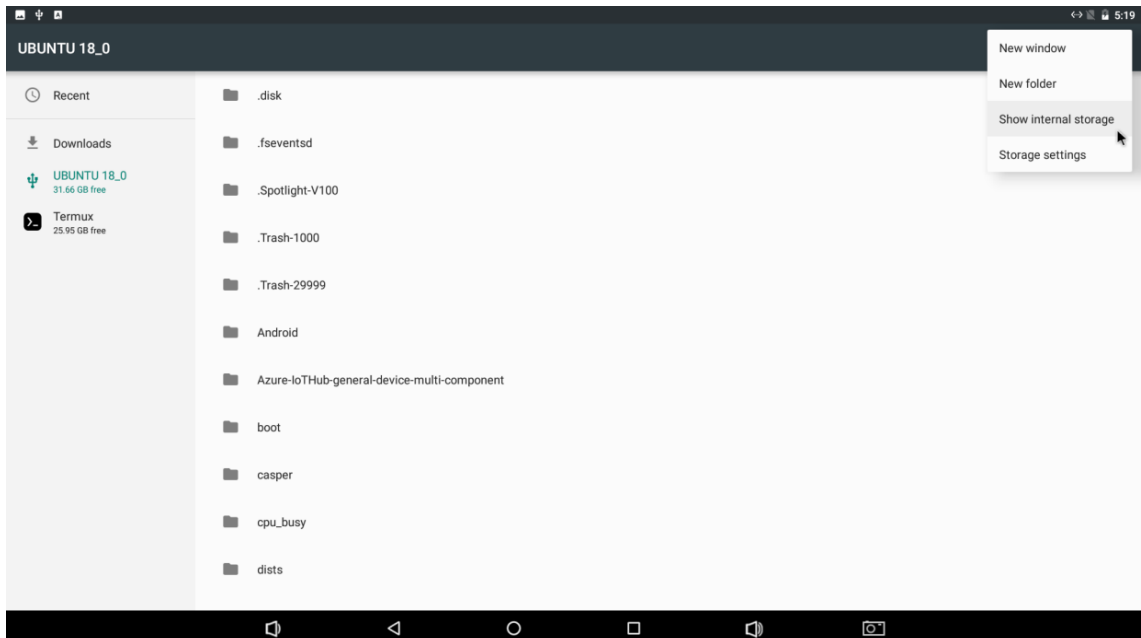

**Step 4** Click the corresponding device icon to access the files.

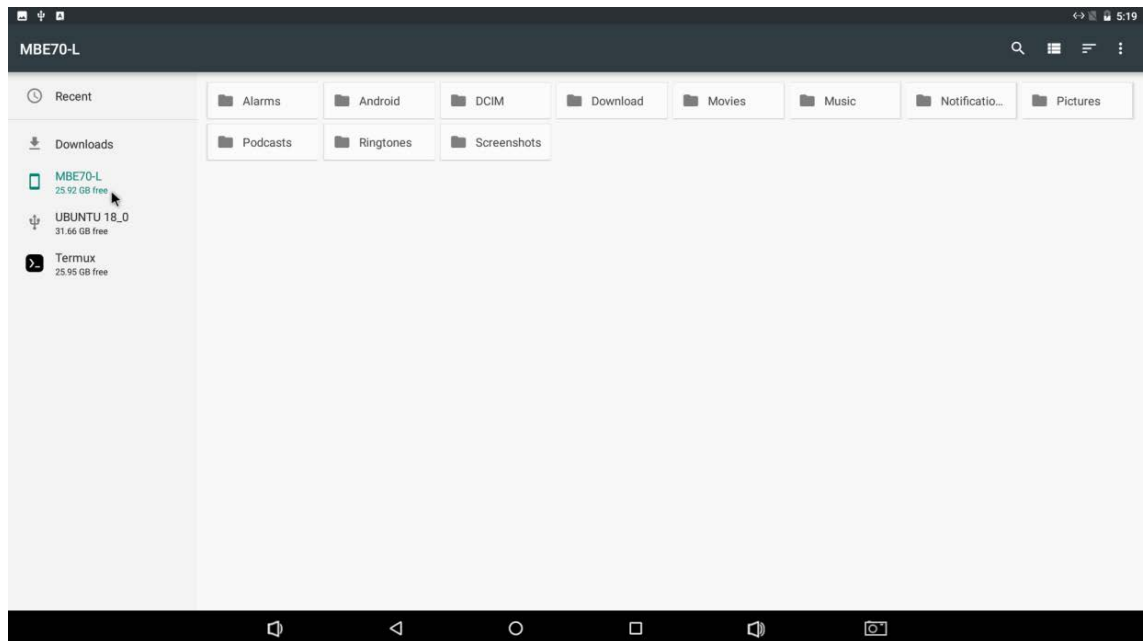

### 4.7.3 SD Card

You can configure the SD card as portable or internal storage device.

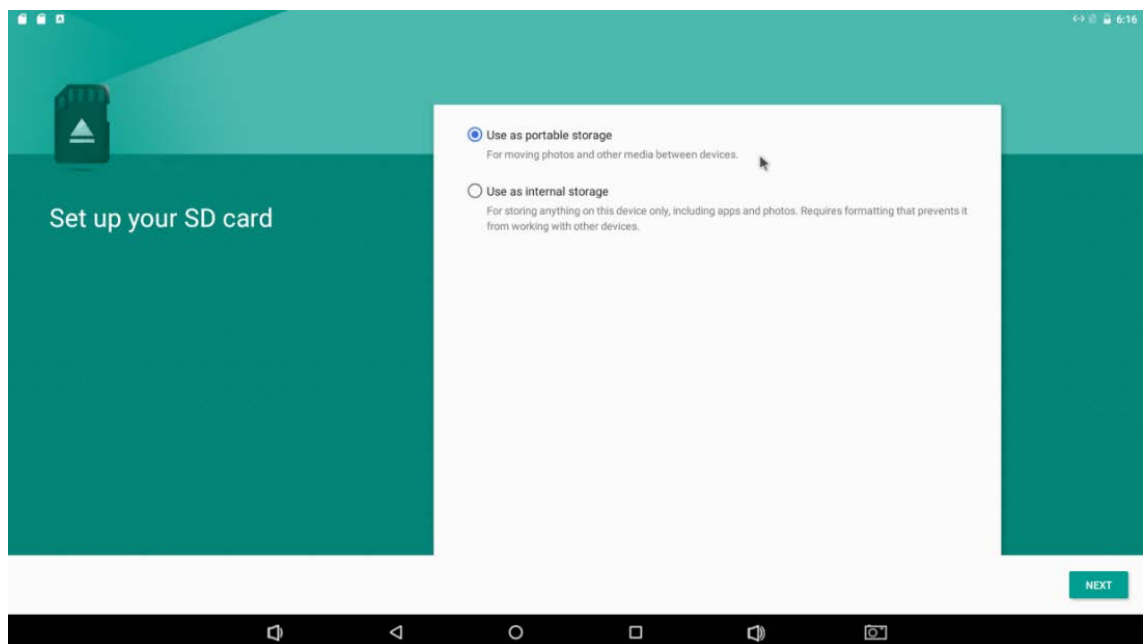

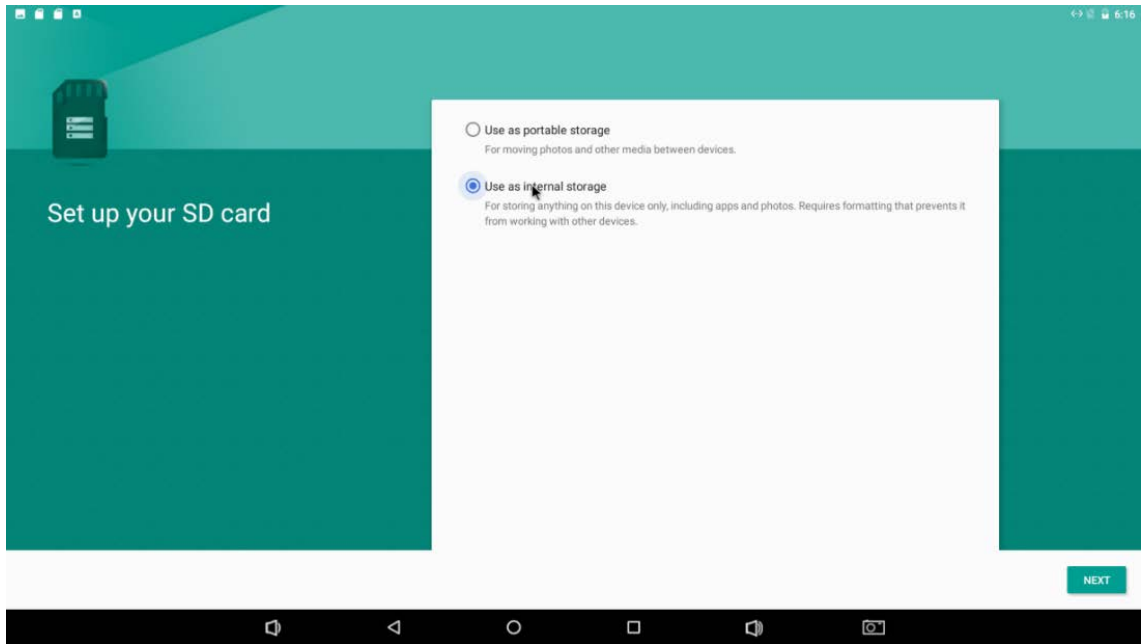

**Step 1** Click the upper-left icon on the desktop.

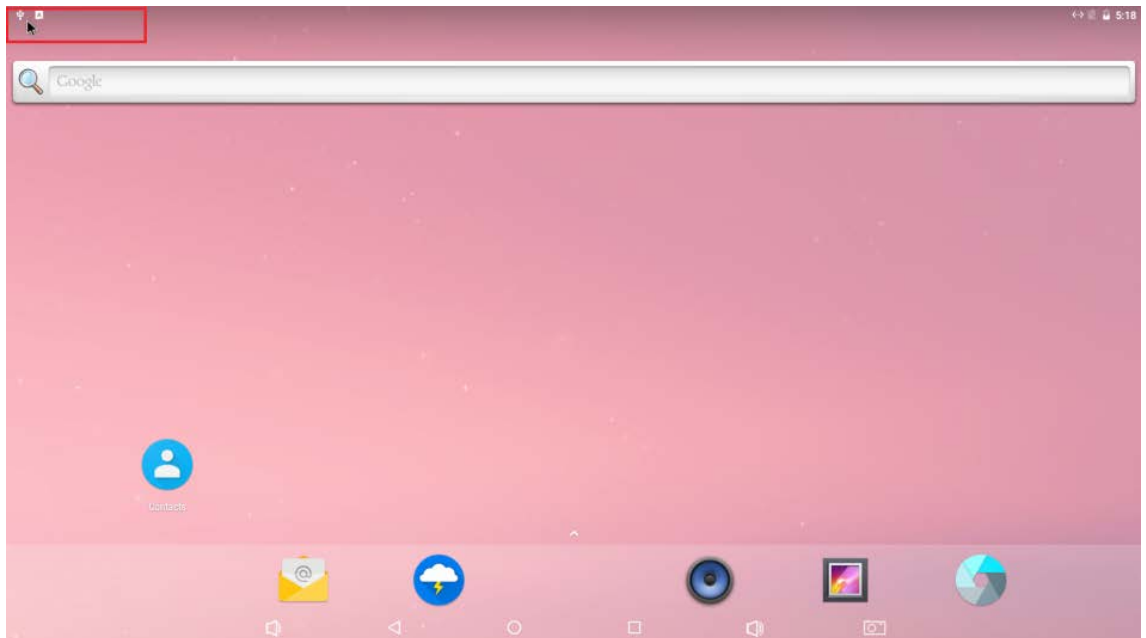

**Step 2** Click "Explore" to open file manager.

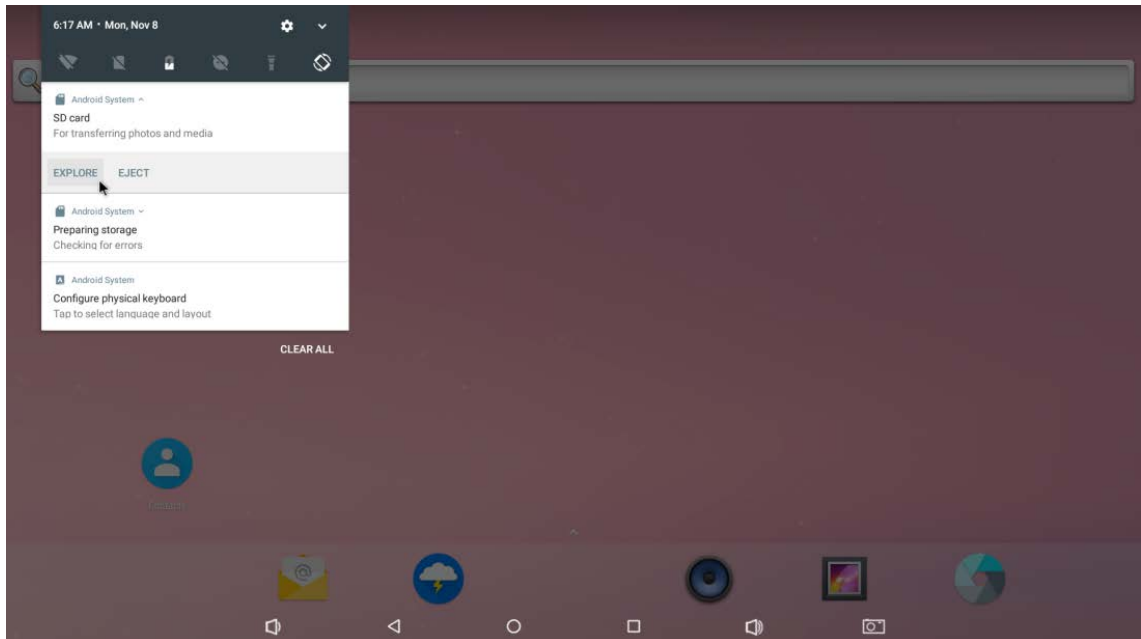

## 4.8 Display

**Step 1** Enter Settings and select "Display".

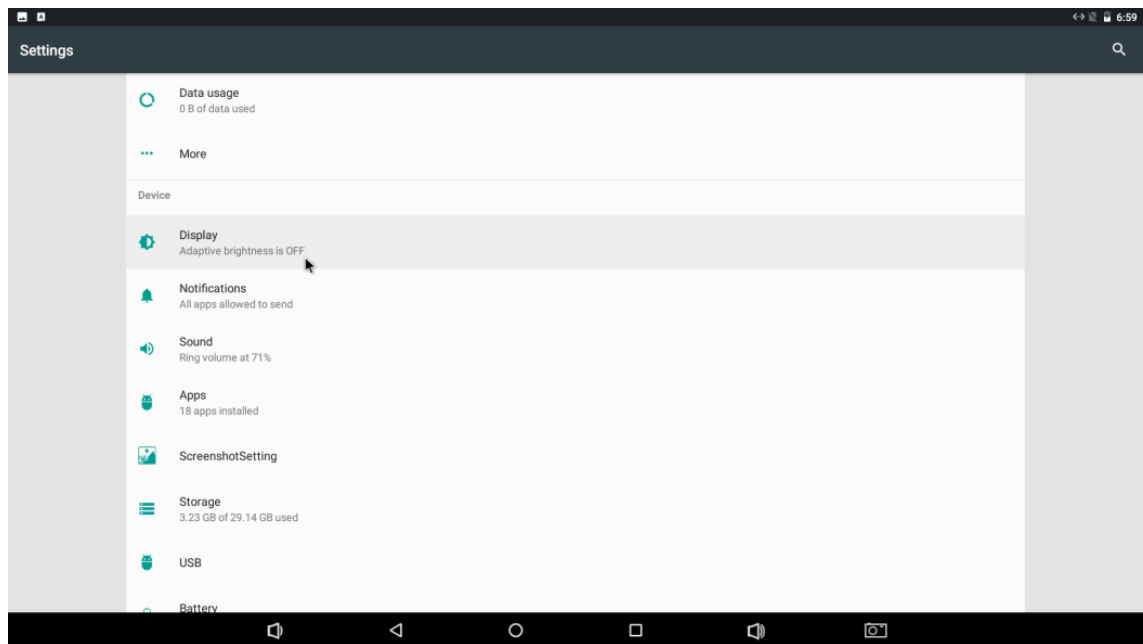

**Step 2** Select "HDMI".

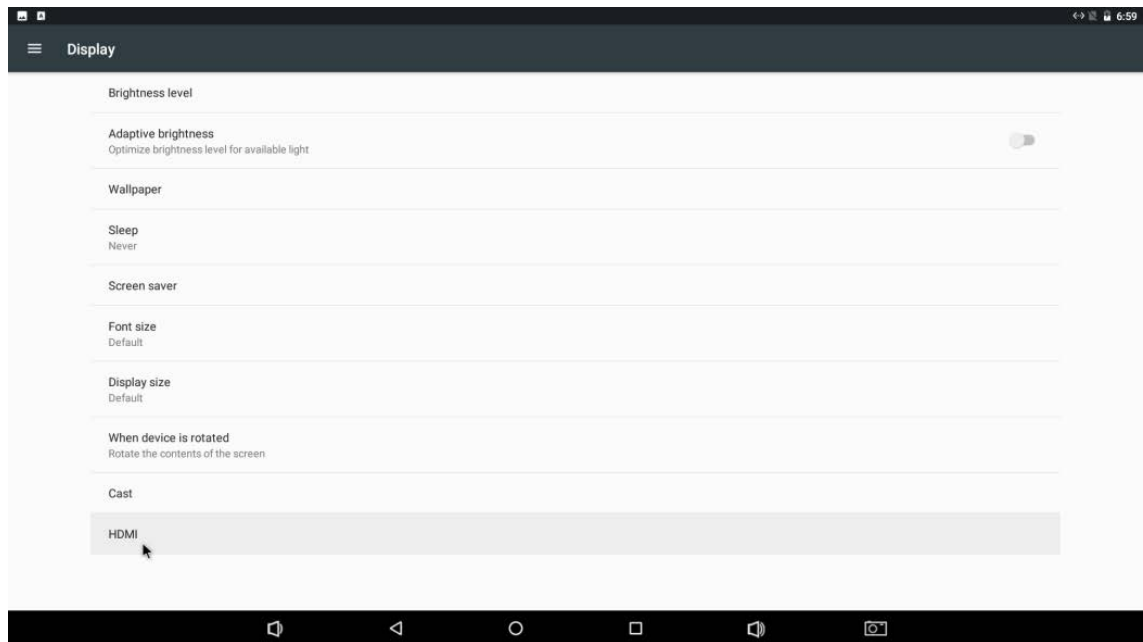



**Step 3** The settings of the display, e.g., resolution and rotation, can be changed in this section.



## 4.9 Audio

You can use the built-in software (Music & Sound Recorder) for the audio function.

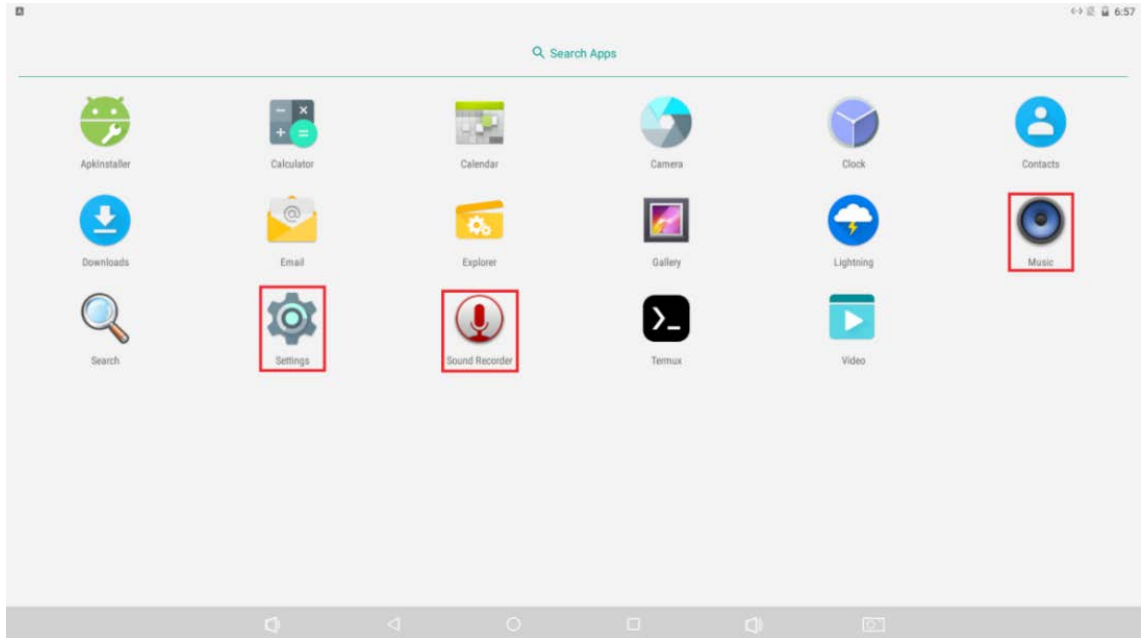

To adjust volume, go to "Settings" and select "Sound".

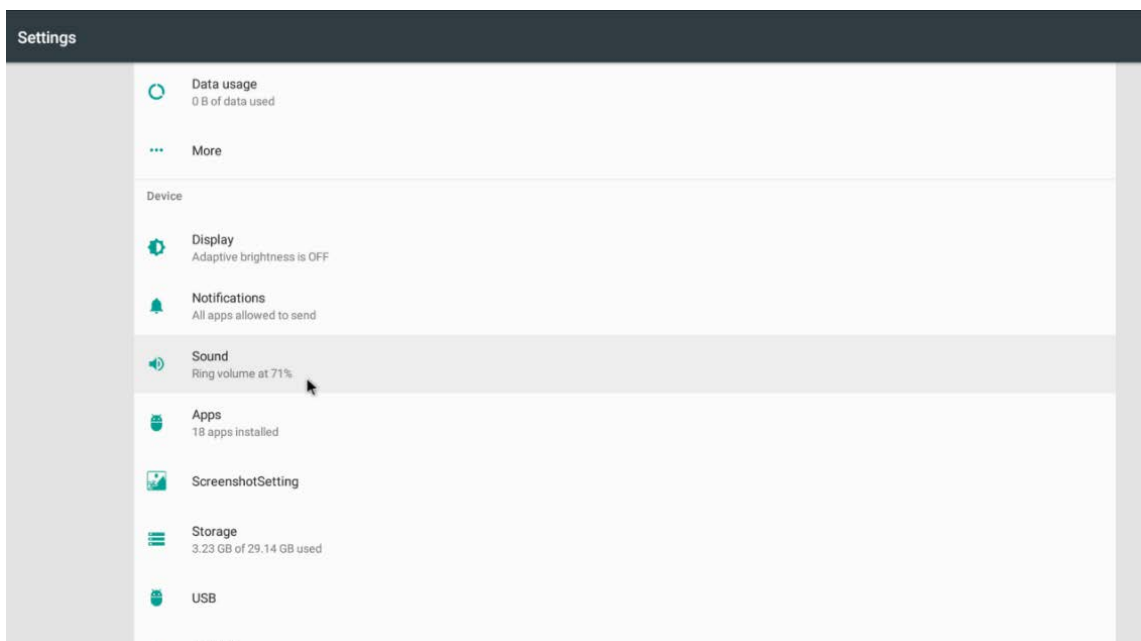

For Debian OS, you need to install the third-party recording software (tinyAISA) to use the recording function. Below is the installation method.

```
$ sudo apt-get update
```

```
$ sudo apt-get install gcc
```

```
$ unzip tinyalsa-master.zip
```

```
$ cd tinyalsa-master
```

```
$ sudo make install
```

```
$ tinymix -D 1 set 31 1
```

```
$ tinymix -D 1 set 43 1
```

```
$ tinymix -D 1 set 44 1
```

# A

## APPENDIX A : POWER CONSUMPTION

Testing Board	EIC-1000
RAM	DDR3L-1066 SDRAM, 2GB
USB-1 : (USB 3.0)	USB MicroSD card reader (with 4GB)
USB-2 : (USB 3.0)	USB MicroSD card reader (with 4GB)
Micro SD	Sandisk Ultra 32GB
Storage	eMMC Flash memory, 32GB
LAN 1 (Realtek RTL8211E)	1.0 Gbps
Graphics Output	HDMI
Power Plan	Default , Debian GNU/Linux 9.13 (stretch)
Power Source	Chroma 62006P-100-25
Test Program	Stress-ng Test

### A.1 RK3399 Dual Cortex-A72 & Quad Cortex-A53 Processor

Power on and boot to Linux Debian GNU/Linux 9.13 (stretch)

CPU	Power Input	Linux Debian GNU/Linux 9.13 (stretch)			
		idle status CPU		Run BurnInTest/Stress-ng Test	
		Max Current	Max Consumption	Max Current	Max Consumption
RK3399 Dual Cortex-A72 & Quad Cortex-A53 Processor	9V	0.434A	03.91W	0.975A	08.78W
	12V	0.320A	03.84W	0.726A	08.71W
	24V	0.180A	04.32W	0.349A	08.38W
	36V	0.131A	04.72W	0.263A	09.47W
	55V	0.094A	05.17W	0.175A	09.63W



For further support information, please visit [www.vecow.com](http://www.vecow.com)

This document is released for reference purpose only.

All product offerings and specifications are subject to change without prior notice.

No part of this publication may be reproduced in any form or by any means, electric, photocopying, or recording, without prior authorization from the publisher.

The rights of all the brand names, product names, and trademarks belong to their respective owners.

© Vecow Co., Ltd. 2021. All rights reserved.